

**Commissioning and
Maintenance Instructions**

be in motion be in motion

TAM 00695

DST2-135 – 400 W

Three-phase synchronous motor
Water-cooled

Version: 05 / 2017
English

LEGAL NOTES ON DOCUMENTATION

Copyright

This documentation is only permitted to be copied by the owner for internal use. As many copies as required may be made. For other purposes, this documentation may not be copied or duplicated either in whole or in part. Utilisation and provision of the contents to third parties is not allowed. Names and company logos in this documentation may be trademarks, which, if used by third parties for their own purposes, may result in infringements of the rights of the owner.

Applicability

This documentation is part of the unit/the machine. These Commissioning and Maintenance Instructions must be available to the operator at all times and be in a readable condition.

On the sale/storage of the unit/machine, this documentation must be passed on together with the unit/machine by the owner. Following the sale of the unit/machine, this original and all copies are to be passed on to the purchaser. Following disposal or any other form of termination of utilisation, this original and all copies are to be destroyed.

With the introduction of this documentation, earlier issues of are superseded.

Please note that the details/figures/information represent **current values at the time of going to press**. These details are **not legally binding** for the purpose dimensioning, computation and calculation.

Baumüller Nürnberg GmbH reserves the right to change the technical data and the method of operation of Baumüller products in the context of the further development of the products.

No liability can be accepted concerning the correctness of the product information unless otherwise specified in the General Conditions of Sale and Delivery.

BAUMÜLLER NÜRNBERG GmbH
Motor Division
D-90482 Nürnberg
www.baumueller.com

Table of contents

1	General Safety Instructions	4
1.1	Safety	4
1.2	Designated use	5
1.3	Prohibition of unauthorised modifications and changes	6
2	Operating conditions	6
2.1	Product description	6
2.2	Items supplied	7
2.3	Nameplate	7
2.4	Technical Data	8
2.5	Transport, intermediate storage	8
2.6	Installation conditions, cooling details	9
2.7	Balancing, drive elements and vibration	10
3	Mounting	11
3.1	Safety instructions	11
3.2	Installation, fixing	11
3.3	Electrical connections	13
4	Commissioning, operation	14
4.1	Safety instructions	14
4.2	Checks prior to commissioning	15
4.3	Commissioning, operation	15
4.4	Malfunctions	16
5	Inspection and maintenance	17
5.1	Inspection	17
5.2	Maintenance	18
5.3	Re-lubrication (optional)	19
6	Disposal	19
7	Appendix 1: pole assignment (main connection and control port)	20
7.1	Main connection with terminal box	20
7.2	Control port : Resolver:	21
7.3	Control port : SRS / SRM 50	21
7.4	Control port: ECN 1313 / EQN 1325	22
8	Appendix 2: water-cooled machines	23
8.1	Definitions of power ratings for water-cooled machines	23
8.2	Motorcooling	23
8.3	Instructions for installation	23
8.4	Electrical connections	24
8.5	Specifications for required coolant volume flows	24
8.6	Coolant consistency	24
8.7	Min. coolant temperature against ambient temperature and humidity	25
8.8	Inspection	26
9	Appendix 3: information concerning thrust-bearing motors and oil-features	27
9.1	Information on permissible axial forces on thrust-bearing motors	27
9.2	Specifications for oil quantities	27
9.3	Specifications for oil service life	27

1 General Safety Instructions

1.1 Safety

This electric motor has been constructed in accordance with the relevant safety standards and underwent an operational safety check before leaving our factory.

To ensure correct commissioning and safe utilisation, please read the following:

- these Commissioning and Maintenance Instructions and if applicable the enclosed supplementary parts
- the enclosed safety and commissioning notes
- the technical documentation that accompanies the product
- the commissioning and safety notes provided by the manufacturer of the converter
- the national, local and system-specific regulations concerning your finished product.
- The technical instruction of TAM 00697 for use in safety-oriented applications

We draw your attention to the following hazards when using the product:

- Hazards resulting from
- lifting and transport processes
 - electrical current
 - moving parts
 - hot surfaces
 - EMC disturbances
 - mechanical overloads
 - thermal overload

To avoid damages to persons and property and minimize residual risks, please read all of the safety instructions and, in particular, those that are marked with a symbol.



Danger to life through electrical shock

Non-observance can lead to death or a grave injury.



Warning concerning general dangers

Non-observance can lead to serious injury or damage to material assets.



Warning concerning dangerous situation

Non-observance can lead to damage of system or peripheral equipment.



Do not touch!

Non-observance can lead to serious injury.



Unpermitted action

Non-observance can lead to serious injury.



Warning concerning hot surface

Non-observance can lead to serious injury.



Electrostatically sensitive components

Non-observance can cause damage to the plant or the environment.

1.2 Designated use

The electric motor must only be used for its designated purpose. In this context, the electric motor must only be used for the applications described in this technical documentation under strict observance of all the notes in these Commissioning and Maintenance Instructions.

All assembly, commissioning, maintenance and operating tasks must be carried out by **qualified personnel** only.

Within the context of these safety instructions, qualified personnel refers to persons who are trained and authorized in the specialized area, who are authorized to set up, assemble, commission and operate devices, systems and circuits under application of the applicable safety standards (in accordance with DIN EN 50110-1).

Inappropriate action can cause serious damage to persons and property.

The **electric motor** is designed to be used for **industrial applications** and is subject to a number of **standards** and **directives**, including the following:

Standards

EN 60034-1, EN 60034-5, EN 60034-6, EN 60034-7, EN 60034-9, EN 60034-11,
EN 60034-14, EN 60204-1

Low Voltage Directive EC

The electric motors in this series fully comply with the requirements of the Low Voltage Directive EC (conformity).

EMC Directive EC

The operation of the electric motor in accordance with its designated use must comply with the safety requirements in the EMC Directive EC. The proper installation (e. g. separation of signal lines and power cables, screened lines and cables etc.) is the responsibility of the erector of the installation and the system provider. During converter operation the EMC information of the converter-, encoder- and brake-manufacturer must be observed.

All national, local and system-specific regulations must also be followed!

The electric motor is designed for the following **ambient conditions**:

- Ambient temperature: 0 °C to +40 °C
- Altitude: ≤ 1000 m above sea level
- Relative humidity: 5 % to 85 %

Please take note of any deviating details specified on the nameplate or in the technical documentation. The conditions at the place of utilization must correspond to the details on the rating plate.



Utilization in hazardous areas is **prohibited**, unless the unit is expressly designed for this purpose (refer to additional notes). Furthermore, the area surrounding the electric motor must be free of inflammable gas mixtures and concentrations of dust. Live and hot motor parts are inflammable and may cause serious injury and damage to property.

If, in special cases, greater requirements are placed – for utilization in non-industrial applications – (e.g. protection against contact with a child's fingers), these conditions must be by the customer met when installing the system.

Motor design with rare-earth magnets:

	<p>Please be aware of the following risks in the vicinity of a retracted or exposed rotor with a strong magnetic field:</p> <ul style="list-style-type: none">• People with electronic or metallic implants (e. g. cardiac pacemakers, hearing aids, plates or pins) are at risk, if the distance between the implant and the magnetic pole is less than 0.5 m.• Due to the strong attraction forces exerted on ferromagnetic parts there is a risk of:<ul style="list-style-type: none">○ Crushing injuries○ Damage to measuring and assembly tools, credit cards, watches etc.○ Contamination of the rotor assembly due to attracting metal debris or powder
---	---

Thermal hazards:

	<p>Caution! Highly inflammable!</p> <p>Temperatures of over 70 °C can build up on the motor surfaces. Touch contact measures should be implemented if necessary!</p> <p>Temperature-sensitive parts, e.g. normal cables or electronic components, must not be placed on or fixed to the hot surfaces.</p> <p>Thermal overloading can destroy the winding and the bearing. A thermal sensor should be used to monitor the temperature.</p>
---	--

1.3 Prohibition of unauthorised modifications and changes

	<p>For safety reasons, unauthorised modifications and changes to the electric motor are not permitted. If such modifications / changes are necessary, please contact the manufacturer.</p> <p>No safety devices may be dismantled or decommissioned prior to the operation of the device.</p>
---	---

2 Operating conditions

2.1 Product description

Electric motors of the series “**DST2...W**” are permanently excited, high-pole, three-phase synchronous motors with rare-earth magnets.

An innovative motor concept with integrated liquid cooling (water-based coolant) ensures a high torque density at low and medium speeds and a robust and compact design.

The elimination of the fan unit significantly reduces noise emission and provides for a high level of protection. In connection with the low-maintenance motor design, these motors are ideally suited for direct drive applications with production machines (e.g. printing presses, extruders, injection molding machines etc.).

Thrust-bearing motors: Thanks to the integration of an axial thrust bearing turning in oil, very high return pressures, e.g. such as those that occur in extrusion, can be taken up by the motor shaft. This makes the low-maintenance motors the best for use as a direct drive for production machines (e.g. extruders etc.).

Moreover, when operating with a motor-controlled pulse converter, the speed and position of these compact motors can be optimally controlled. These drives have a high overload capacity and are therefore ideally suited for applications in mechanical engineering.

2.2 Items supplied

The delivery is put together on an order-related basis.

- The carrier must immediately be notified of any damage caused during transport.
- On delivery, please check that the ratings and motor type correspond with the order data. In the event of apparent defects or incomplete delivery, the appropriate Baumüller office or the Baumüller head office in Nuremberg should be notified immediately.

In both of the above cases, commissioning must not take place until the error has been rectified by a specialist.

2.3 Nameplate

The nameplate is used to identify each electric motor. The unique motor number is clearly shown on each nameplate and is essential for internal tracking procedures. The nameplate must be legible at all times. Never remove the nameplate from your motor.

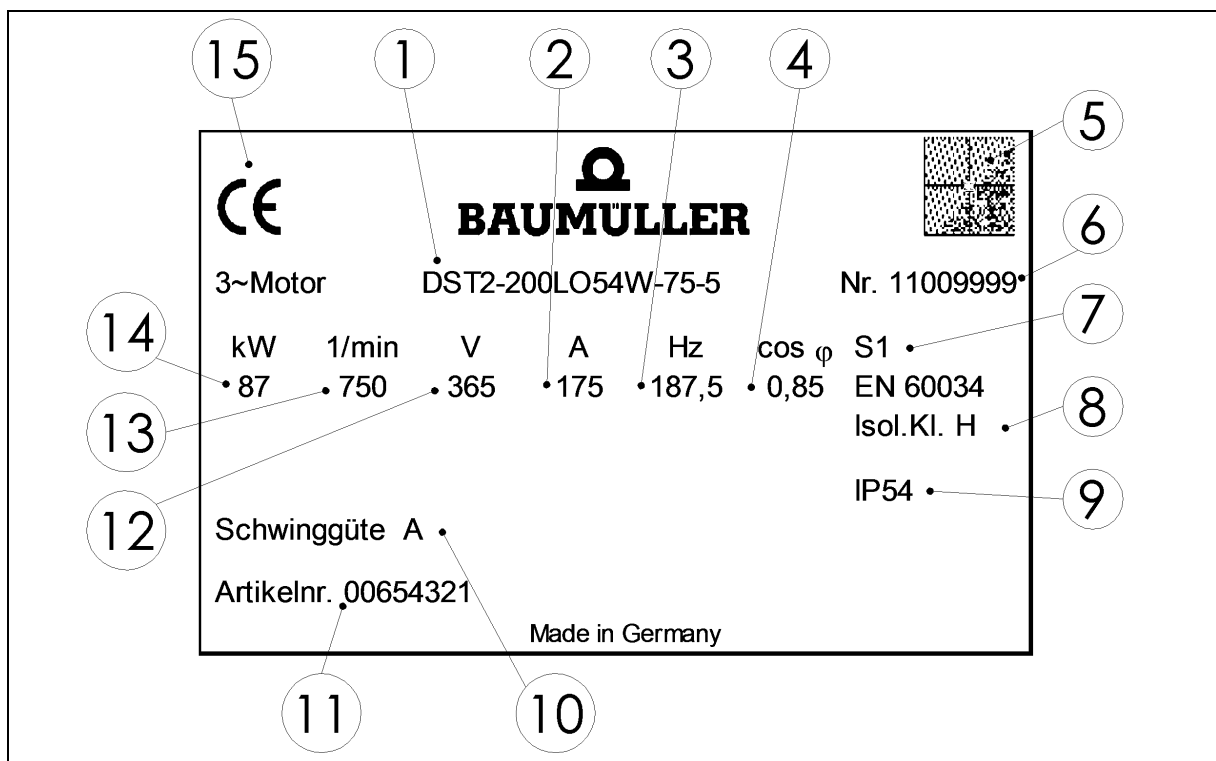

Figure 1: Nameplate

- | | | | |
|-----|--------------------------|------|-------------------------|
| 1 → | Motor type / designation | 9 → | Motor protection class |
| 2 → | Rated current | 10 → | Balance quality |
| 3 → | Rated frequency | 11 → | Article number |
| 4 → | Power factor | 12 → | Rated voltage |
| 5 → | 2D Code | 13 → | Rated speed |
| 6 → | Motor number | 14 → | Rated power |
| 7 → | Motor operating mode | 15 → | Standards and approvals |
| 8 → | Thermal class | | |

2.4 Technical Data

The technical data you can find in the technical product list **DST2-135 - 400 W**- or online at: www.baumueller.com under Download and Technical documentation. If necessary, you can request the corresponding documentation

Storage	Class 1K2/1M1 according to DIN EN 60721-3-1:1995
Transport	Class 2K2/2M1 according to DIN EN 60721-3-2:1995

Note:

To avoid frost damage, cooling water should be removed at ambient temperatures < 3 °C!

Bearing	Rolling bearings with permanent grease lubrication (optional: re-lubrication)
Thrust-bearing	Axial spherical roller bearing with oil lubrication
Calculated bearing life	Lh 10 = 20000 h (guideline value)

Caution!

If the electric motor supplied is not a standard type according to the technical list or if special contractual arrangements have been made, there may be differences in the information contained in these Commissioning and Maintenance Instructions. If this is so, request the relevant technical supplements.

2.5 Transport, intermediate storage

Water-cooled motors:

	To avoid frost damage it must be ensured that there is no coolant in the motor during the transport or intermediate storage at ambient temperatures < 3 °C.
---	---

Transport:

	<p>The permitted environmental conditions which affect the motor during the transport must be taken from DIN EN 60721-3-2 (class 2K2/2M1). Contrary to the DIN, a reduced temperature range of – 15 °C to + 60 °C is permitted.</p> <p>Suitable load lifting tackle must be used, e. g. belt webbing and loop belts. If provided, the lifting lugs of the motor can be used for lifting.</p> <p>The terminal boxes and motor connectors must not be used for securing the motor for transport or as lifting eyes.</p> <p>The regulations of the respective countries must be adhered to during transport. Lifting devices and transport and lifting tackle must comply with the relevant regulations.</p>
---	---

Series “DST2-..VA..” electric motors have the following weights in the overall length classes:

DST2-135 KO to YO	DST2-200 KO to XY	DST2-260 KO to XO	DST2-315 KO to ZA	DST2-400 KO to XY
approx. 100 kg to approx. 185 kg	approx. 200 kg to approx. 470 kg	approx. 370 kg to approx. 860 kg	approx. 450 kg to approx. 1,250 kg	approx. 2100 kg to approx. 3600 kg

Table 1: Weights of DST2-.. VA-motors

“DST2-..DG..” with thrust bearings have the following weights in the overall length classes:

DST2-135 KO to YO	DST2-200 KO to XY	DST2-260 KO to XO	DST2-315 KO to ZA	DST2-400 KO to XY
approx.130 kg to approx. 215 kg	approx. 280 kg to approx. 550 kg	approx. 520 kg to approx. 1050 kg	approx. 720 kg to approx. 1500 kg	approx. 2200 kg to approx. 3800 kg

Table 2: Weights of DST2-.. DG-motors

Please refer to your delivery documentation for the exact weight specifications.

Note on thrust-bearing motors:

The motor must only be transported horizontally and standing on its feet, or else the oil filler plug with the air hole (see **Appendix 3 – Fig. 8** on the bearing end plate, side A, must be replaced with a solid screw plug (M20x1.5).

The motor shaft and the connection surfaces must be protected against corrosion. The motor must only be transported with a shaft protection cover; damage to the motor shaft must be avoided.

Intermediate storage:

If a motor is not to be commissioned immediately after delivery, it should be stored inside a building in an inside room which is dry, dust-free and free of significant vibration ($V_{rms} \leq 0.2$ mm/s).

The electric motors should be stored at as uniform a temperature as possible, not outside of the temperature range -15 to +60 °C, for no more than two years. Elevated storage temperatures within the framework of the working temperature accelerate the rate at which seals and bearing grease deteriorate and therefore have a negative impact on the service life even before the unit has been commissioned. Direct exposure to incident solar radiation, UV light and ozone also lead to an ageing of the gaskets and must be avoided!

Please note that the guarantee periods start from the date of delivery. We therefore recommend that storage periods be kept to a minimum.

Should nevertheless a longer storage be necessary, the environmental conditions acc. to DIN EN 60721-3-1 (class 1K2/1M1) have to be observed. Contrary to the DIN, an expanded temperature range of – 15 °C to + 60 °C is permitted.

2.6 Installation conditions, cooling details



For motors with water-cooling please take Section 8 into account in addition.

Surroundings:

The motor can be installed in roofed rooms in dusty or damp environment and under normal climatic conditions.

Unless alternative arrangements have been made, the motor is designed by default for the following climatic conditions:

- Ambient temperature 0 °C to 40 °C
- Installation height ≤ 1000 m above sea level
- Relative humidity 5 % to 85 %

All other allowed application conditions have to correspond to DIN EN 60721-3-3 (class 3K3/3Z12).

It is absolutely imperative to comply with these climatic conditions when installing the unit.

Aggressive, corrosive, abrasive and plastic-dissolving solutions should be kept well away from the motor and the air that is used to cool it.

Consultation with the motor manufacturer is essential in the case of installation outdoors.

2.7 Balancing, drive elements and vibration

	<p>The shaft and bearing must not be exposed to knocks.</p> <p>No axial forces are permitted when mounting or dismantling the output elements.</p> <p>The generally required measures to prevent contact with the output elements must be observed.</p> <p>If the motor is commissioned without the output element, the featherkey must be secured to ensure that it is not thrown out.</p>
---	---

Balancing:

With the standard version, the rotors are dynamically balanced as per EN 60034-14 ISO 8821 / ISO 1940 using a half key; does not apply for thrust-bearing motors.

NOTE: Observe the type of balancing as identified on the shaft end face:

H = Balancing with half key	Standard version
F = Balancing with full key	Special version

Output elements:

When mounting the output element, note the appropriate type of balancing. The output elements must themselves be balanced in accordance with ISO 1940.

Suitable jigs are always to be used for fitting or removing output elements (e.g. clutch disk, gear, pulley).

- Use the threaded hole in the end of the shaft.
- When pulling, use intermediate washers to provide the shaft with mechanical protection.
- Warm up output elements if necessary before mounting (max. admissible transient temperature at shaft end 150 °C).

Attention:

- On shaft versions without a key, the output elements are to be fastened to the output shaft **with the aid of suitable clamping sets**.
- On shaft versions with a key, it must be ensured that **the output elements rest on the shaft shoulder**. Note: The chamfer or radius on the output element and the shaft radius on the shoulder (in accordance with DIN 748) must be matched.
- Is the tapped hole in the end of the shaft used for axial securing of output elements (e.g. belt pulley), the maximum tightening torque acc. to following table 3 must not be exceeded.



	thread	tightening torque in Nm
	M5	2,2
	M8	10,0
	M10	19,0
	M12	33,0

Table 3: Tightening torque for safety screw S of a belt pulley

appropriate measures for securing screw must be applied

Vibration:

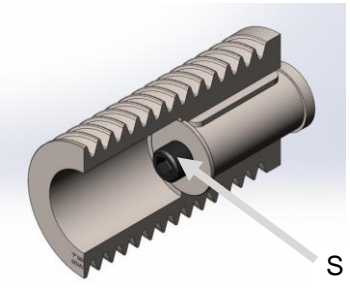
	<p>The site vibration response of the system, which is determined by the output elements, the mounting conditions, the alignment, the installation and the effects of external vibrations, may cause the vibration values at the motor to increase.</p> <p>In the interest of reliable motor operation and a long bearing service life, the permitted vibration values in accordance with EN 60034-14 should not be exceeded. Under certain circumstances, the rotor may need to be fully balanced with the output element (in accordance with ISO 1940).</p> <p>The vibration value after assembly must not exceed the permitted rates of acceleration (comp. Section. 2.4).</p> <p>In the event of deviations from normal operation – e.g. rise in temperature, noises, vibration – disable the motor. Identify the cause and, if necessary, contact the manufacturer.</p>
---	---

3 Mounting

3.1 Safety instructions

Before mounting:

	<p>Never mount or commission a damaged electric motor.</p> <p>Never install the electric motor in a damaged machine.</p> <p>Before mounting the electric motor, make sure that it is suitable for your machine.</p>
--	---

During mounting:

	<p>Only mount the motor on the fixing possibilities provided.</p> <p>The motor should not be exposed to knocks, e.g. with a hammer, or shocks when mounting.</p> <p>Make sure that all covers and safety devices are mounted. All safety devices must comply with the latest regulations (e. g. EN 60204).</p> <p>Water cooling:</p> <p>To avoid damaging the housing, only screwed sockets with a cylindrical thread may be used for the water connections (inlet and outlet).</p> <p>The coolant pipes should not exert compression-tension forces or torsional strain on the motor connections.</p> <p>The connection must be carried out by specially trained personnel. Here, the motor must be disconnected and de-energized.</p> <p>When coupling and uncoupling the coolant pipes, make sure that coolant does not enter into the motor's terminal box.</p>
---	--

3.2 Installation, fixing

Prior to and during mounting, check that

- the motor is not damaged (e. g. the shaft sealing ring must not have sustained any damage at all from sharp or pointed objects).
- oil is not leaking near the A-side thrust bearing.
- the motor is not mounted in the danger zone of other facilities.

- the motor is used for the designated purpose (See **Sections 1.2** and **2.4**).
observe nameplate details, warning labels and signs.
- anti-corrosive agents are fully removed from the shaft ends.
When using standard solvents such as Acetone or benzene, the shaft sealing ring must not be moistened!
- the motor is designed for the ambient conditions and environmental influences on site (see **Section 2.4**).
- the compartment in the machine is suitable for the cooling method employed by the electric motor (see **Section 2.6**).
The motor must be installed in such a way that the coolant lines can subsequently be connected.
- there is enough room in the machine for connecting the motor and for inspection and maintenance work.
For the installation dimensions of the motor and tolerance specifications, please refer to the technical documentation or your provided dimensional drawing.
- the motor can be mounted and operated with the connection data and fixing possibilities provided.
The mounting dimensions of the motor and the tolerance details are provided in the technical documentation.
*When mounting the flanges on the motor, make sure that the flange surface rests well and evenly. The supports and bearing surface must be clean and undamaged. They must be precisely aligned with the connecting shafts to prevent the bearing, shafts and housing being exposed to damaging loads through misalignment. When tightening the flange fixing screws, (**min. property class 8.8**) make sure that the flange connection is not twisted.*
- no liquid can penetrate the upper bearing when installing vertically with the shaft end facing upwards. **Note:** Thrust-bearing motors may only be operated horizontally.
- the permitted radial forces in accordance with the operating characteristics in the technical documentation are not exceeded. If necessary, contact Baumüller. The motor manufacturer must always be contacted in the case of axial forces.
- the brake (optional) can be released after feeding the operating voltage (audible creaking sound).
- the rotor rotates smoothly without making a scraping sound.
If the motor is equipped with a brake, the brake should be released previously.
- the design of the motor and encoder cables complies with the details in the technical documentation.
- the output and input elements are secured. With thrust-bearing and hollow-shaft motors, sufficient contact protection on the open B-side shaft end during operation must be ensured.
- the complete cooling circuit is leak proof and fully functional and protected against any foreign objects falling into it.



3.3 Electrical connections

Important notes:

	<p>All work must be carried out by specially trained personnel.</p> <p>Work must only be carried out when the system has been de-energized and secured against unintentional restarting (also auxiliary circuits).</p> <p>Work may only be carried out once the machine has come to a standstill.</p> <p>In the case of three-phase synchronous motors with permanent-magnet excitation, a voltage of > 60 V can occur at the motor terminals when the rotor is turning.</p> <p>Regulations for working in electrical plants must be adhered to!</p>
---	---

Attention! The safety regulations for work in electrotechnical plants in accordance with EN 50110-1 (DIN VDE 0105-100) must be observed:

- Disconnect the system
- Secure against unintentional restarting
- Verify safe isolation from supply
- Earth and short
- Safeguard or cover adjacent live parts

	<p>The electric motor must be operated via a correspondingly designed converter. A direct connection to the three-phase mains can destroy the motor.</p> <p>Ensure that the phase sequence and the pin assignment are correct!</p> <p>Electrical connections, protective conductor connections and screening connections (when using screened cables) must be permanently secure!</p>
	<p>Never touch the contacts of the encoder or thermal sensor with your hands or with tools that are electrostatically charged. The encoder and the thermal sensor are electrostatically sensitive components.</p>

Electrical installation:

- The supplier of the system is responsible for the correct electrical installation.
- The motor data on the nameplate must be observed.
- Connection cables and plug connections must be checked for any occurring voltages and current intensity and must be suitable for the method of installation employed.
- The motor and the modules (brake, encoder etc.) must be connected in accordance with the details in the wiring diagrams (comp. enclosed wiring diagrams / **Appendix 1**).
- Screened power and encoder cables must be used to protect against electromagnetic EMC interference from motor cables and their effect on the encoder and control system. Please refer to the EMC notes provided by the supplier of the converter.
- To enhance operational safety, we recommend that the ready-made connection cables from Baumüller be used.
- Prior to connection, the female connectors, connectors and terminal box must be checked for damage, corrosion, dirt and dampness.
- Ensure the connections are made correctly and are tight. Seals and sealing faces on the connectors and the terminal boxes maintain the type of protection.
Note! Also in the interests of safeguarding the degree of protection, the rotatable junction boxes should not be turned in their direction of connection more than 5 times altogether.
- Connectors and terminal box connections must not be exposed to mechanical stress. If necessary, provide strain, shearing, twist and antikink relief.

In case of connection using a terminal box it is to be ensured

- the insulation is not over stripped, i. e. that the insulation extends right up to the cable lugs or terminals. The ends of the cables must not protrude.
- the cable lugs that are used are suitable for the dimensions and cross-sections of the terminals and cables.
- the screwed electrical connections are tightened in accordance with the specified tightening torque (comp. **Appendix 1 table 5**).
- the protection type is maintained.

Note: All lead-ins that are not used must be closed off with the sealing caps. The sealing elements must be fully functional and undamaged when closing the terminal box.



4 Commissioning, operation

4.1 Safety instructions

Working on the electric motor:

	<p>Work must not be carried out on the electric motor until the motor had come to a standstill and is de-energized. All connections, such as screw connections, that were loosened must be tightened again prior to commissioning.</p> <p>When carrying out work on the motor, please observe the technical instructions and notes in the respective sections in these Commissioning and Maintenance Instructions.</p> <p>Attention: If the optional holding brake is fitted, it must not be used to secure anything while working on the motor (e. g. for retaining loads)!</p>
---	---



Danger to life through electrical shock:

 	<p>Make sure that the motor is disconnected and de-energized.</p> <p>Never disconnect the motor connections while in operation.</p> <p>Only connect measuring device when motor is disconnected from power supply and de-energized.</p> <p>Only commence work on the motor connections when you are sure that the motor is de-energized and that there is no electric potential.</p> <p>When in operation, electric potential can be found at the motor terminals/contacts and at the motor windings. Never touch these modules/elements while the motor is in operation.</p>
--	---

Installing and uninstalling safety devices:

	<p>The electric motor must not be commissioned without first mounting the safety devices.</p> <p>The motor must be put out of operation when installing and dismantling components and systems which are provided for monitoring the motor for safe operation..</p>
---	---

Danger on contact:

 	<p>Make sure that the electric motor has come to a standstill and is secured against accidental restarting before you touch it.</p> <p>Only touch the drive shaft when it is de-energised and the motor has come to a standstill. Otherwise, danger through rotating rotor.</p> <p>Danger of burns! Never touch the motor housing when motor is running at rated load. Surface temperatures can rise up to 70 °C.</p>
--	---

4.2 Checks prior to commissioning

- The drive is undamaged and is not located within the danger zone of other equipment
- The motor is correctly aligned and fixed. All screwed connections are correctly tightened. Unused connection threads in the end shield have to be closed.
- The motor is not leaking oil; oil is not exiting from the leak hole (compare to **App. 3 – Fig.1**).
- All the appropriate safety devices (mechanical, thermal and electrical) are mounted.
- The motor connections have been carried out correctly.
- The protective conductor system is correct and its functionality has been checked.
- The lines and cables do not come into contact with the motor surface.
- The drive does not block (release brake, if applicable).
- Emergency OFF functions have been checked.
- The coolant pipes have been properly corrected and the functionality of the cooling circuit has been tested.

4.3 Commissioning, operation

Note on brake function (if present):

	The brake is designed as a holding brake with an emergency stop function. (power failure and emergency stop) It must not be used as a working brake.
---	--

Commissioning must be carried out exclusively by qualified personnel

Please refer absolutely to the commissioning instructions for the converter and the cooling system.

Checks during commissioning





- Release brake, if applicable.
- Has the functionality of all motor modules such as the brake, encoder, cooling system been checked and are the utilization conditions being adhered to?
- Have all electrical connections been carried out and fixed as required by the regulations (Refer to wiring diagrams / **Appendix 1 or enclosed wiring diagrams**)?
- Have all protection measures that eliminate the possibility of contact with live parts, hot surfaces, rotating and moving parts been observed and are these measures fully functional?
- Have all output elements been mounted and set in accordance with the manufacturer's instructions?
- Are measures in place to ensure that the max. permitted speed n_{max} of the motor cannot be exceeded. The max. permitted speed n_{max} is the highest permitted operating speed for short-time duty?
- The maximum permissible axial force (*compare to **Appendix 3***) is not exceeded

Checks during operation

- Watch out for unusual noises.
- If scraping, scratching or grinding noises occur, stop the motor immediately and locate the cause.
- Check the motor surface and connection cables for dirt, e. g. layers of dust, oil deposits, dampness and leaks etc.
- Check the maintenance intervals.

4.4 Malfunctions

Safety instructions:

	Troubleshooting and error recovery may only be carried out by qualified personnel. Do not disconnect any of the safety devices – even during test operations
	Only disconnect coolant pipes when depressurized
	Only disconnect and connect electrical connection cables when in de-energized and protected condition Observe the 5 safety rules for “Disconnecting” (comp. Section 3.3).
	Beware of hot surfaces!

In the event of a malfunction

- refer to the operating instructions of the machine/system
- refer to the operating instructions for the converter
- If necessary, contact the manufacturer of the motor or converter

Have the following parameters ready:

nameplate data
type and scope of malfunction
circumstances leading up to the malfunction
application data (torque cycle, speed and forces over time; ambient conditions)

The following selection possible causes can be helpful in the fault correction process:

Fault	Cause	Recovery
Motor does not start	No controller enable Controller error, encoder error Brake does not release Brake defect No power supply Rotating field	Activate controller enable Read out error list at converter or controller, rectify error Check connections and power supply Repair by manufacturer Check connections and power supply Check phase sequence, if necessary, replace connecting cables
Uneven running	Insufficient screening on connecting cables Controller parameters too high	Check screening connection and grounding Optimise controller parameters
Vibrations	Coupling element or work machine poorly balanced Inadequate alignment of the drive train Fixing screws loose	Rebalance Realign machine set Check and tighten screwed connections
Running noises	Foreign matter in motor Damaged bearing	Repair by motor manufacturer Repair by motor manufacturer

Fault	Cause	Recovery
Temperature rise in motor Motor temperature monitoring unit responds	Drive overloaded Brake does not release fully - scraping brake Water cooling not active. Coolant supply inadequate - filter urgently requires cleaning - deposits in cooling channels - disturbances in external cooling system	Check motor load and compare with nameplate Repair by motor manufacturer Check and, if necessary, switch on Check water circuit - check and, if necessary, clean - check and, if necessary, clean - follow system supplier's instructions
Excess pressure in cooling system	Coolant impure Cooling channels blocked Disturbances in the external cooling system	Filter coolant Check and, if necessary, clean Follow system supplier's instructions
Current consumption too high, motor torque too low	Indexing angle incorrect	Check indexing angle and adjust if necessary
Oil leak on A-side shaft extension or leak hole (Appendix 3)	Shaft sealing ring damaged or worn	Repairs carried out by motor manufacturer

Table 4: Malfunctions

5 Inspection and maintenance

Working on the electric motor:

	<p>Work must not be carried out on the electric motor until the motor has come to a standstill, is de-energized, depressurised and has cooled. All connections, such as screw connections, that were loosened must be tightened again after the inspection or maintenance work.</p> <p>When carrying out work on the motor, please observe the technical instructions and notes in the respective Sections in these Commissioning and Maintenance Instructions.</p> <p>When carrying out maintenance work, observe all safety instructions which also apply for the commissioning of the motor (comp. Section 4.1).</p> <p>Attention!: If the optional holding brake is fitted, this brake must not perform a safety function during work on the motor (e. g. retaining loads)!</p>
---	---

5.1 Inspection

Depending on the pollution severity on site, cleaning will have to be carried out regularly to guarantee the continuous dissipation of heat loss. The flow rate and the pressure ratio of the cooling system must be checked.

If an optional brake is fitted, wear limits are specified (e. g., maximum permissible operating air gap, maximum number of emergency braking operations). The actual degree of wear on the brake must be checked at regular intervals. When the permissible wear limits have been reached, the brake must be replaced (see **Section 5.2**).

If equipped with the optional shaft sealing ring, this must be checked regularly to ensure that it is functioning correctly (leaks).

Note on thrust-bearing motors: An inspection hole for leak oil from the thrust-bearing housing is located on the bottom of the A-side bearing end plate near the feet (see **Appendix 3 – Fig. 1**). If oil exits here, the shaft sealing rings of both sealing points must be replaced.

5.2 Maintenance

Depending on the operating conditions, (e. g. mode, temperature, speed and load), the service life of the bearings and sealing elements can differ greatly.

Maintenance work (except for oil changes) must be carried out by Baumüller or a specialist company commissioned by Baumüller.

In the case of troublefree operation, we generally recommend the following maintenance procedures:

- replacement of the **bearings** after 20000 running hours (The bearings are designed for a calculated service life of 20000 running hours)
- In case of hollow-shaft motors: replacement of the **encoder, encoder-bearing** and **toothed belt** after 20000 running hours.

In the case of **thrust-bearing motors**, we generally recommend the following maintenance guidelines:

- First **oil change** after about 5000 operating hours. All subsequent oil change after 10000 operating hours. Oil lubrication (sump) with **high-performance synthetic gear oil** – "Klübersynth GH6-320" (Klüber Lubrication) or "Omala S4 WE 320"(Shell) or „Degol GS 320“ (ARAL).
- A change of shaft sealing, in case of presence, must be implemented when leakage occurs.

Note on oil changes:

Do not begin draining the oil until the motor is secured and the housing parts have cooled down to room temperature!

For quicker emptying, unscrew the filler and drain plugs.
(compare to **Appendix 3 – Fig. 8**).

Fill the thrust-bearing housing with the appropriate oil; the motor should be horizontal when doing so. The required oil level is reached when the oil drips out of the opened oil level screw (overflow principle).

For the approximate oil quantity, please refer to **Appendix 3**.

If an optional **brake** is fitted, it is essential that it is replaced when its wear limits are reached.

Caution!

The specifications of the technical instructions TAM 00697 must be followed during maintenance and servicing on motors which are used for safety-oriented applications.

5.3 Re-lubrication (optional)

Attention: Re-lubrication only with grease outlet open.

Prior to re-lubrication it is imperative that the covers be removed from the grease outlet opening.

Re-grease bearing with re-lubrication device only when the motor is running.

After re-lubrication, 2 - 4 hours of motor operation is necessary (the old bearing grease is ejected from the grease outlet opening by the rotation of the bearing), the cover is then to be refitted to the grease outlet opening.

The theoretical bearing service life as well as the specified motor protection type can only be maintained if the grease outlet opening is sealed with the cover supplied during operation.

Re-lubrication intervals and grease quantities can be found on the sign on the motor.

6 Disposal

The motor must be disposed off in accordance with the national and local regulations within the framework of the normal recycling process.

Attention: The rotors of the DST motors have rare-earth magnets with high magnetic energy densities. See also the note in **Section 1.2**.

The encoder electronics (if provided) must be disposed of in the proper manner as electronic scrap.

Before you open the thrust-bearing motor, the oil for thrust-bearing lubrication must be drained via the locking screw (**Appendix 3 – Fig. 8**).

The oil is to be disposed of separately as mineral oil.

7 Appendix 1: pole assignment (main connection and control port)

7.1 Main connection with terminal box

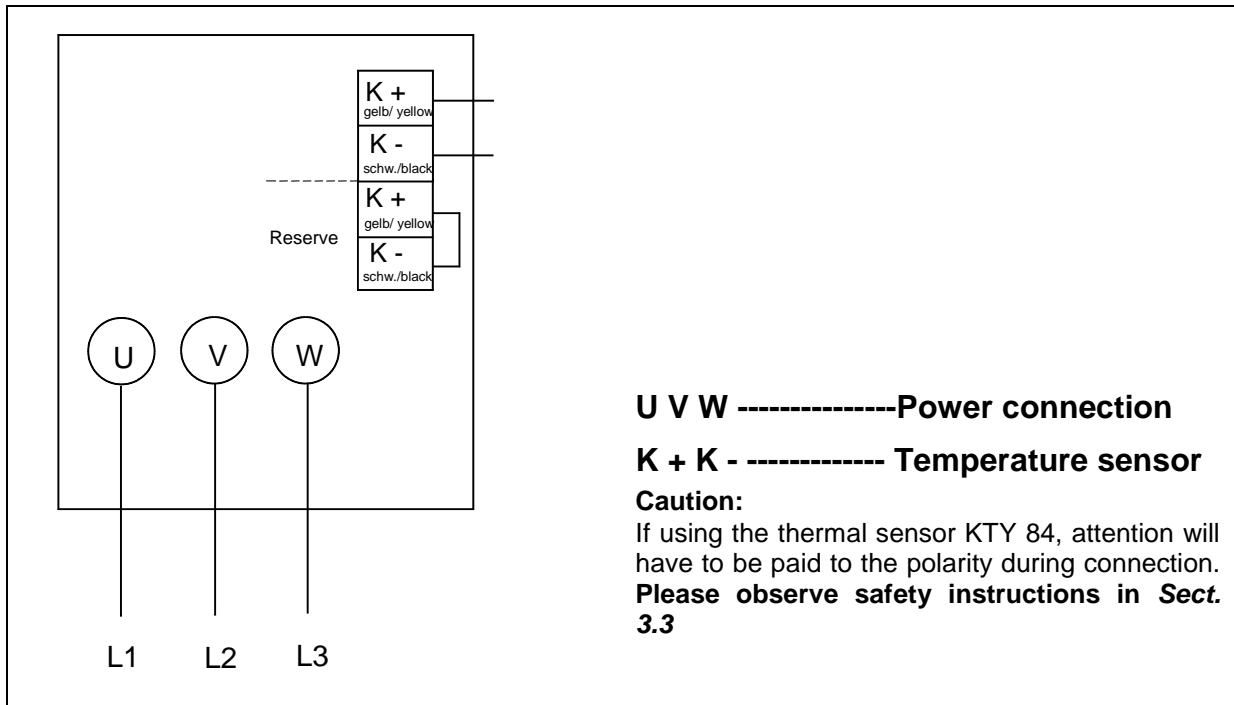

Figure 2: Main connection with terminal box

The cable inlets of the terminal boxes and the main connection terminals are listed below together with the permitted tightening torque.

We recommend EMC screwed fittings for the cable inlets.

It is recommended when tightening the terminal screw to support against the conductor to prevent mounting rail deformation and to keep the terminal base free of torsional forces.

Please refer to the **Technical Product list DST2-135 - 400 W** for the size of the cable glands and terminals.

The following tightening torques M_a for the nuts on terminal boards, Wago-clamps etc. must be kept:

thread	M3,5	M4	M5	M6	M8	M10	M12	M16	M20
tightening torque M_a in Nm	0,8	1,2	2,0	3,0	6,0	10,0	15,5	30,0	52,0

Table 5: Tightening torque for screw nut

7.2 Control port : Resolver:

	Pin	Signal
 <p>View to contact side of female connector</p>	1	cos -
	2	
	3	
	4	
	5	sin -
	6	sin +
	7	
	8	cos +
	9	
	10	Ref +
	11	
	12	Ref -

Figure 3: Pool assignment resolver

7.3 Control port : SRS / SRM 50

(encoder with Hiperface-port from SICK / Stegmann companies)

	Pin	Signal
 <p>View to contact side of female connector</p>	1	ref cos
	2	+ 485
	3	
	4	
	5	sin
	6	ref sin
	7	- 485
	8	cos
	9	Schirmung
	10	Gnd
	11	
	12	+ U

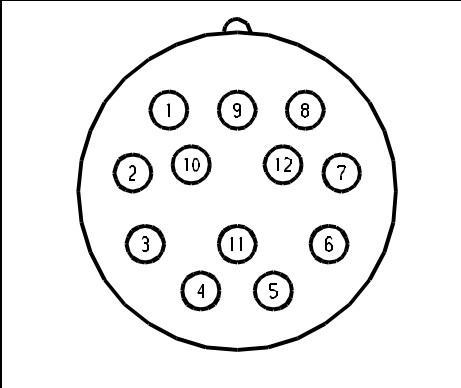
Figure 4: Pool assignment SRS / SRM 50

7.4 Control port: ECN 1313 / EQN 1325

(encoder with EnDat 2.1-port from Heidenhain companies)

	Pin	Signal
 <p>View to contact side of female connector</p>	1	U _p
	2	
	3	
	4	0 V
	5	
	6	
	7	U _p
	8	Clock
	9	Clock inv.
	10	0 V
	11	
	12	B+
	13	B-
	14	Data
	15	A+
	16	A-
	17	Data inv.

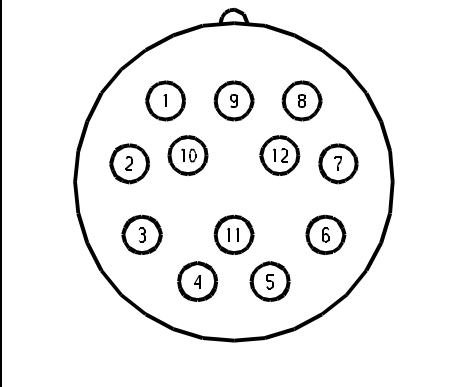
Figure 5: Pin assignment ECN 1313 / EQN 1325

Note:

- For other encoder types and optional lead for the temperature sensor via the encoder cable, see the enclosed wiring diagram or technical documentation for the pin assignment
- The encoder from Section 7.2 to 7.4 are components susceptible to ESD.

8 Appendix 2: water-cooled machines

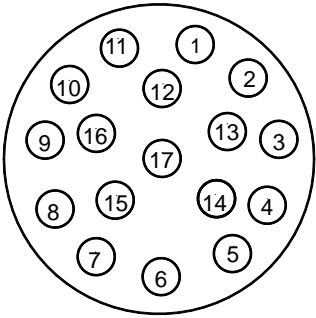
In addition to the previous chapters for water-cooled motors (EN 60034-6; IC 3W7) the following must be considered complementary:

8.1 Definitions of power ratings for water-cooled machines

The power ratings (torques) that appear in the list apply to permanent operation S1 at nominal speed, provided the cooling circuit requirements for water-cooled motors are met!

The reduction factors included in the table below must be considered when operating DST2 motors with higher coolant inlet temperatures:

Coolant inlet temperature	25 °C	30 °C	35 °C	40 °C	45 °C
Percentage of list performance (torque)	100 %	97 %	95 %	92 %	89 %

Table 6: Reduction factors

8.2 Motorcooling

The coolant (in accordance with the coolant properties specified in **Section 8.6**) is permitted to contain corrosion inhibitors and anti-bacterial additives. The type and volume of these additives is based on the respective manufacturer's recommendations and the prevailing ambient conditions.

	<p>The safety regulations for the product from the manufacturer of the corrosion inhibitors and anti-bacterial additives must be observed.</p> <p>Cooling lubricants employed in the manufacturing process are not allowed to be used to cool the motor!</p> <p>To prevent blockages and deposits in the coolant pipes and channels, coolants used in closed or open cooling circuits must be filtered. When used in a closed cooling circuit, the coolant must be filtered before it is poured in, in open cooling circuit basically (filter fineness: < 0.1 mm).</p>
---	---

Note: The system manufacturer is responsible for the planning of the cooling circuit. Condensed water must not be allowed to accumulate.

8.3 Instructions for installation

Cooling connection:

Size	135	200	260	315	400
Connections Flow	1	1	1	1	1
Return	1	1	1	1	1
Connection thread (female)	G1/4"	G3/8"	G1/2"	G1/2"	G1"
Direction of flow	Any				

Table 7: Cooling connection

	<p>Water cooling:</p> <p>The coolant pipes should not exert compression-tension forces or torsional strain on the motor connections.</p> <p>The connection must be made by specially trained personnel. During this process the motor must be disconnected and electrically isolated.</p> <p>When coupling and uncoupling the coolant pipes, make sure that coolant does not enter the motor's terminal box.</p>
---	---

**Leak test acc. to EN 50178:**

The cooling system is to be checked for leaks before commissioning by pressure testing with coolant (water). The test pressure must be twice the operating pressure (minimum test pressure 1 bar). The coolant used does not have to be brought to operating temperature for this purpose. Pressure must be maintained until all areas have been tested for leaks (minimum test duration 10 minutes).

8.4 Electrical connections

The standard power connection for water-cooled motors has to be carried out according to the dimensional drawings of the technical documentation.

8.5 Specifications for required coolant volume flows

For information about the required quantities of cooling please consult the product list DST2-135 - 400W.

8.6 Coolant consistency

The coolant must satisfy the following specifications:

Conditions	Unit	Value
Maximum permissible system pressure	bar	6
Temperature of coolant- for motor	°C	10 to 25
pH value (at 20 °C)	---	6.5 to 9
Overall hardness	mmol / l	1.43 to 2.5
Chloride - Cl-	mg / l	< 200
Sulfate - SO ₄ ²⁻	mg / l	< 200
Oil	mg / l	< 1
Permissible particle size of solid foreign objects, particles (e.g., sand)	mm	< 0.1

Table 8: Coolant consistency

Clean water that is free of dirt and suspended matter must be used as a coolant.

8.7 Min. coolant temperature against ambient temperature and humidity

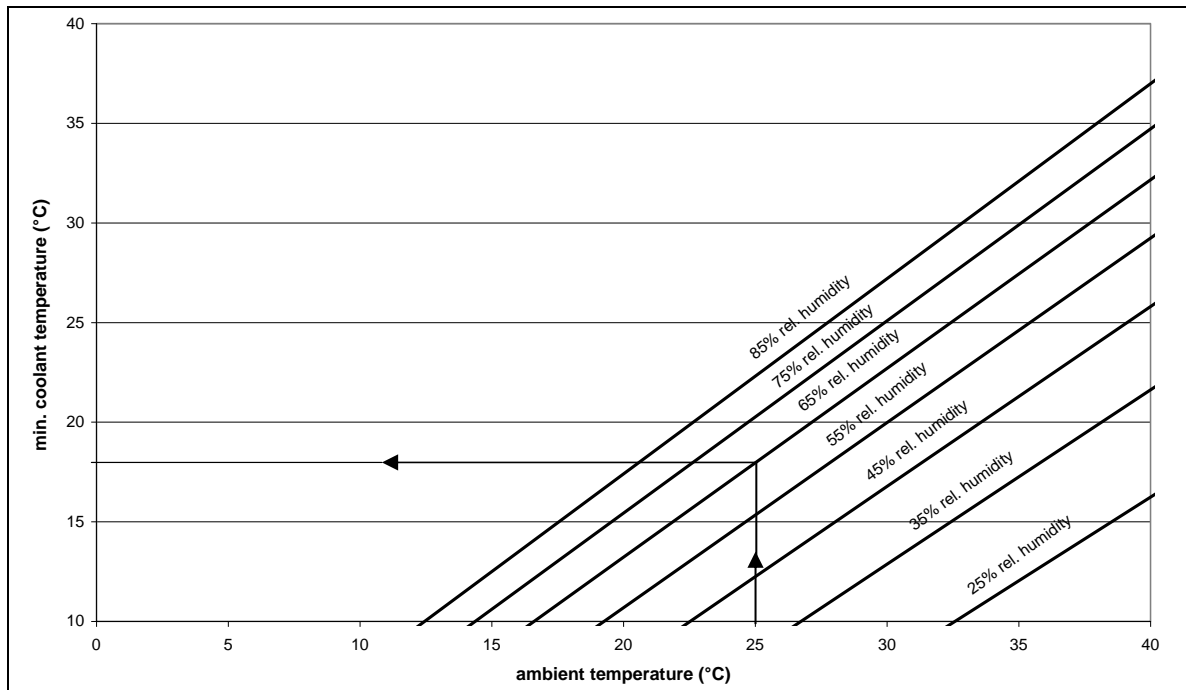

Figure 6: Determination of the coolant temperature

The allowed coolant temperature depends on relative humidity and ambient temperature. For example with an ambient temperature of 25 °C and a relative humidity of 65 % the minimum coolant temperature is 18 °C. Because these are limiting values on practical side a coolant temperature greater than 18 °C should be used.

If this minimum coolant temperature will be under run the two- point controller of Baumüller drive must be used to avoid condensation (see **figure 7** on next page).

Note:

For standstill of motor for longer time the cooling must be stopped.(to avoid condensation).

If ambient temperatures of < 3 °C may occur during a longer motor standstill, coolant should be discharged as a precaution (to prevent frost damage).

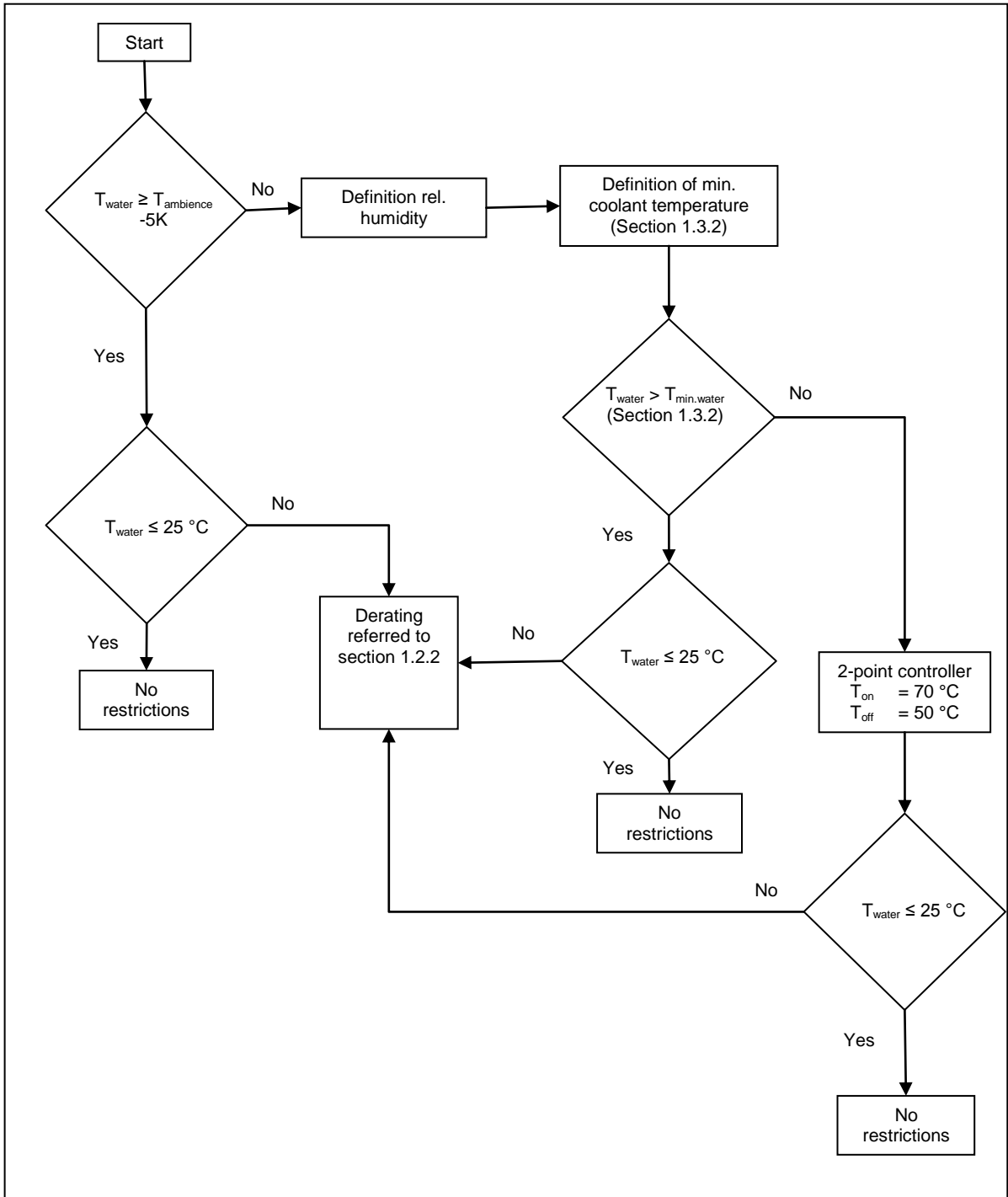

Figure 7: Flow chart coolant temperatur

8.8 Inspection

During regular cleaning the flow rate and the pressure ratio of the cooling system must be checked

9 Appendix 3: information concerning thrust-bearing motors and oil-features

9.1 Information on permissible axial forces on thrust-bearing motors

Direction of force: from the connection side (DE) to the encoder side (NDE)

Please refer to the Technical Product list DST2-135 - 400W for the axial forces possible in relation to the speed.

Size	DST2-135	DST2-200	DST2-260	DST2-315	DST2-400
max. perm. axial force in kN	120	200	270	400	760

Table 9: Permissible axial forces for thrust-bearing motors

9.2 Specifications for oil quantities

Size	DST2-135	DST2-200	DST2-260	DST2-315	DST2-400
Oil quantity in litre	approx. 0.5	approx. 1.5	approx. 2.0	approx. 5.0	approx. 3.0 from length LO approx. 5.0

Table 10: Oil quantity for thrust-bearing motors

9.3 Specifications for oil service life

We recommend changing the oil when changing the shaft sealing rings, but no later than when changing the bearing. See **Section 5.2**.

Mixing oils of different grades or makes is not permitted.

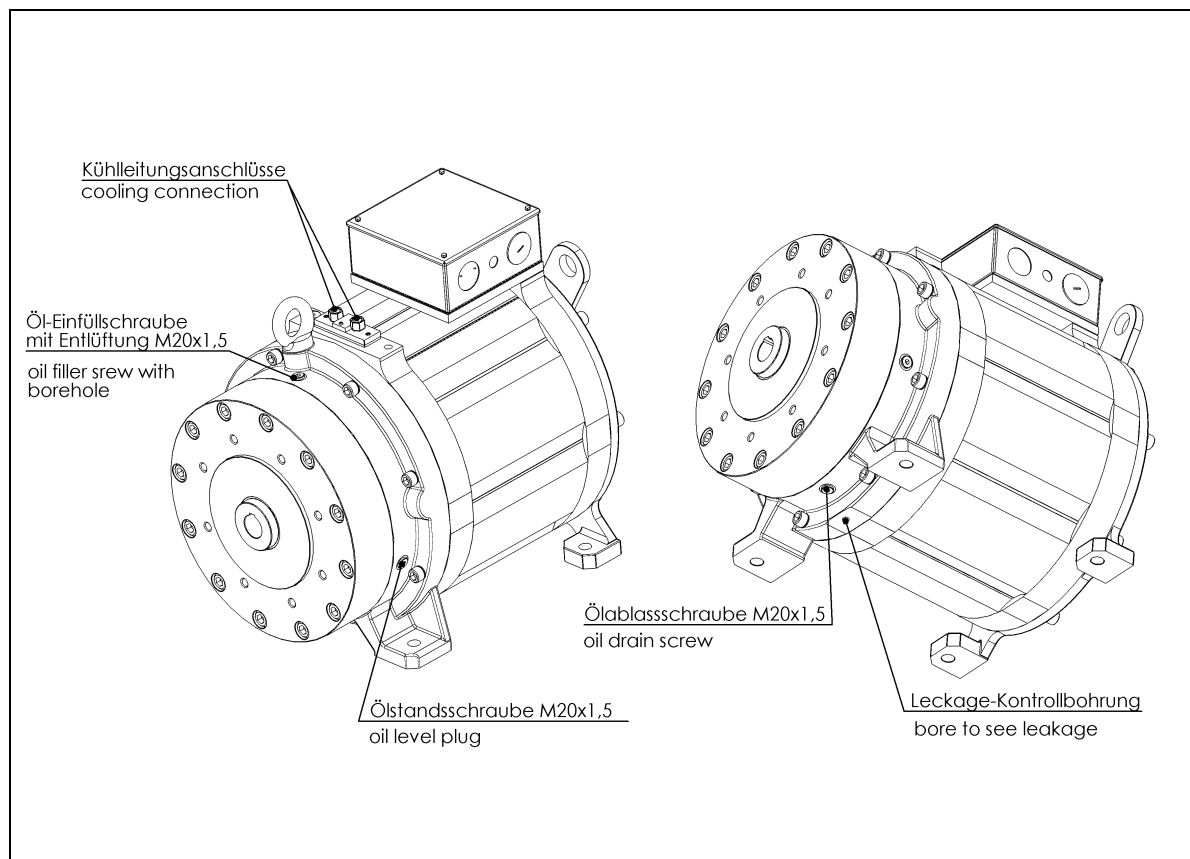

Figure 8: Illustration of thrust-bearing motor

Warranty and liability

All the details in this documentation are unbinding customer information and subject to ongoing change and will be continuously updated by our permanent editing staff. Warranty and liability claims against Baumüller Nürnberg GmbH are excluded if, in particular, the damage is caused by one or more of the following:

- You have not followed the instructions in this documentation.
- You have not used the system for the purpose intended.
- You have
 - mounted, installed, commissioned, operated the system incorrectly or have not carried out the required maintenance
 - permitted the system to be mounted, installed, operated and/or maintained by unqualified or insufficiently qualified personnel,
 - overloaded the system,
 - operated the unit with
 - faulty safety devices,
 - safety devices that were incorrectly fitted or not fitted
 - safety devices or protective devices not in proper working order,
 - not operated the system in the stipulated ambient conditions.
- You have modified the system without the written approval of Baumüller Nürnberg GmbH.
- You have not observed the instructions concerning maintenance in the component descriptions.
- You have not monitored parts subject to wear sufficiently.
- You have made a repair incorrectly.
- You have combined the system with the products from other manufacturers in an improper manner.
- You have combined the drive system with faulty and/or incorrectly documented products from another manufacturer.

The latest version of the General Terms and Conditions of Sale of Baumüller Nürnberg GmbH always apply.

These will be made available to you at the latest on conclusion of the contract.