

**Commissioning  
and Maintenance**

**be in motion be in motion**

**TAM 00612**

**DA 100 – 280 W**

Three-phase asynchronous motor  
Water-cooled

**Version: 08 / 2024**  
**English**

## LEGAL NOTES ON DOCUMENTATION

### *Copyright*

This documentation may only be copied, as many times as required, by the owner for internal use. For other purposes, this documentation may not be copied or duplicated either in whole or in part. Utilization by and provision of the contents to third parties is not permitted. Names and company logos used in this documentation may be trademarks, whose use by third parties for their own purposes may infringe the rights of the owner.

### *Applicability*

This documentation is part of the unit/the machine. These Commissioning and Maintenance Instructions must be available to the operator at all times and be in a readable condition.

If the unit/machine is sold or put into storage, the owner must pass on this documentation together with the unit/machine. Following the sale of the unit/machine, this original and all copies are to be passed on to the purchaser. Following disposal or any other form of termination of utilization, this original and all copies are to be destroyed.

With the introduction of this documentation, corresponding documentation with earlier issue dates is superseded.

Please note that all data/figures/information represent **current data at the time of going to press**. These details are **not legally binding** for the purposes of dimensioning, computation, or calculation.

Baumüller Nürnberg GmbH reserves the right to change the technical data and the method of operation of Baumüller products in the context of the further development of the products.

No liability can be accepted concerning the correctness of this documentation unless otherwise specified in the General Conditions of Sale and Delivery.

BAUMÜLLER NÜRNBERG GmbH

Motors division

90482 Nürnberg, Germany

[www.baumueller.com](http://www.baumueller.com)

# Table of contents

<b>1</b>	<b>General safety instructions</b>	<b>4</b>
1.1	Safety	4
1.2	Designated purpose	5
1.3	Prohibition of unauthorized modifications and changes	6
<b>2</b>	<b>Operating conditions</b>	<b>6</b>
2.1	Product description	6
2.2	Items supplied	6
2.3	Nameplate	7
2.4	Technical Data	9
2.5	Transport, bearing lock, intermediate storage	10
2.6	Installation conditions, cooling details	10
2.7	Balancing, output elements, vibration	11
<b>3</b>	<b>Mounting</b>	<b>12</b>
3.1	Safety instructions	12
3.2	Installation, fixing	13
3.3	Electrical connections	14
<b>4</b>	<b>Commissioning, operation</b>	<b>15</b>
4.1	Safety instructions	15
4.2	Checks prior to commissioning	16
4.3	Commissioning, operation	16
4.4	Malfunctions in operation	17
<b>5</b>	<b>Inspection and maintenance</b>	<b>18</b>
5.1	Inspection	19
5.2	Maintenance	19
<b>6</b>	<b>Disposal</b>	<b>19</b>
<b>7</b>	<b>Appendix 1: Pole assignment (main connection and control port)</b>	<b>20</b>
7.1	Main connection via the terminal box:	20
7.2	Control port: Resolver	21
7.3	Control port: SRS/SRM50	21
7.4	Control port: ECN1313 / EQN 1325 / EQN 425	22
7.5	Control port: ECN1325 / EQN 1337	22
<b>8</b>	<b>Appendix 2: Water-cooling</b>	<b>23</b>
8.1	Cooling circuits	23
8.2	Coolant consistency	25
8.3	Required coolant volume flows	25

# 1 General safety instructions

## 1.1 Safety

This electric motor has been constructed in accordance with the relevant safety standards and underwent an operational safety check before leaving our factory.

To make sure that the machine is commissioned correctly and used safely, please read the following:

- These Commissioning and Maintenance Instructions and their attached appendices
- The safety and commissioning notes
- The technical documentation that accompanies the product
- The commissioning and safety notes provided by the manufacturer of the converter
- The national, local, and system-specific regulations concerning your finished product
- The technical instruction of TAM 00697 for use in safety-oriented applications

We draw your attention to the following hazards when using the product:

- Hazards resulting from
- Lifting and transport
  - Electrical power
  - Moving parts
  - Hot surfaces
  - EMC interference
  - Mechanical overload
  - Thermal overload

To avoid injury to people and damage to property and to minimise residual risks, please read all the safety instructions and, in particular, those which are marked with a symbol.



### **Risk of fatality due to electric shock**

Failure to observe can lead to fatal or serious injuries.



### **Warning about general dangers**

Failure to observe can lead to serious injury.



### **Warning about a dangerous situation**

Failure to observe can lead to damage to the system or peripheral equipment.



### **Touching prohibited**

Failure to observe can lead to serious injury.



### **Improper handling prohibited**

Failure to observe can lead to serious injury.



### **Warning about a hot surface**



### **Electrostatically sensitive components**

Failure to observe can lead to damage to the system or peripheral equipment.

## 1.2 Designated purpose

The electric motor must only be used for its designated purpose. In this context, the electric motor must only be used for the applications described in the technical documentation under strict observance of all the notes in these Commissioning and Maintenance Instructions.

All assembly, commissioning, maintenance, and operating tasks must be carried out by qualified personnel only.

Within the context of these safety instructions, qualified personnel refers to persons who are trained and authorized in the specialized area, who are authorized to set up, assemble, commission, and operate units, systems, and circuits under application of the applicable safety standards (EN 50110-1).

Inappropriate behavior can result in serious injury and damage to property.

The **electric motor** is designed to be used for **industrial applications** and is subject to a number of **standards** and **directives**, including the following:

### Standards

EN 60034-1, EN 60034-5, EN 60034-6, EN 60034-7, EN 60034-9, EN 60034-11, EN 60034-14, EN 60204-1

### EU Low Voltage Directive

The electric motors in this series fully comply with the requirements of the Low Voltage Directive 2014/35/EU (conformity).

### EU Machinery Directive

Electric motors are components which are intended to be installed in machines as described in the Machinery Directive. Commissioning is not permitted until such time as the conformity of the finished product with this directive has been established (refer to EN 60204-1 "Electrical Equipment of Machines").

### EU EMC Directive

The operation of the electric motor in accordance with its designated use must comply with the safety requirements in the EMC Directive EC. The proper installation (e. g. separation of signal lines and power cables, screened lines and cables etc.) is the responsibility of the erector of the installation and the system provider. During converter operation the EMC information of the converter-, encoder- and brake-manufacturer must be observed.

### All national, local and system-specific regulations must also be followed!

The electric motor is designed for the following **ambient conditions**:

- Ambient temperature: 0 °C to +40 °C
- Altitude: ≤1000 m above sea level
- Relative humidity: 10 % to 80 %

Condensed water must not be allowed to accumulate.

Measures to protect against the accumulation of condensed water during water cooling (**see Appendix 2**):

- Entry temperature (coolant) ≥ ambient temperature.
- In climates up to 40 °C and up to 70 % humidity, the inlet temperature (coolant) can be up to 5 K below the ambient temperature.
- The cooling unit must be switched off during longer standstill periods

Please take note of any details specified on the nameplate or in the technical documentation. The conditions at the place of use must correspond to the details on the rating plate.



Use in areas with potentially explosive atmospheres is **prohibited** unless the unit is expressly designed for this purpose (refer to additional notes). Furthermore, the area surrounding the electric motor must be free of inflammable gas mixtures and hazardous concentrations of dust.

Live and hot motor parts are inflammable and may cause serious injury and damage to property.

If, in special cases (for utilization in non-industrial applications), more stringent requirements are in place, e.g., protection against contact with a child's fingers, these conditions must be met by the customer when installing the system.

## Thermal hazard:

	<p>Caution, risk of burns!</p> <p>The <b>surface temperatures</b> on the motors may <b>exceed 70 °C</b>. If necessary, fit guards! Temperature-sensitive parts, e. g., normal cables or electronic components, must not be placed on or fixed to the hot surfaces.</p> <p>Thermal overloading can destroy the winding and the bearing. A thermal sensor should be used to monitor the temperature.</p>
---	--

## 1.3 Prohibition of unauthorized modifications and changes

	<p>For safety reasons, unauthorized modifications and changes to the electric motor are not permitted. If such modifications/changes are necessary, please contact the motor manufacturer.</p> <p>No safety devices may be dismantled or decommissioned when operating the electric motor.</p>
---	--

## 2 Operating conditions

### 2.1 Product description

The "DA - W" series electric motors are 4-pole three-phase asynchronous motors. These motors are liquid-cooled (water-based coolant) and, due to the efficient cooling system, they have a high torque and power density with a high degree of protection. Since there is no fan unit, the noise emissions from the motor are significantly reduced.

When operated with a motor-controlled pulse converter, the speed and position of these motors must also be controlled; they are therefore ideal for applications on tool machines and production machines (e.g. printing and plastic).

### 2.2 Items supplied

The delivery is put together on an order-specific basis.

- The carrier must be immediately notified of any damage caused during transit.
- On receipt of delivery, please make sure that the ratings and motor type agree with the order data. In the event of apparent defects or incomplete delivery, the appropriate Baumüller office or the Baumüller head office in Nuremberg should be notified immediately.

In both of the above cases, commissioning must not take place until the error has been rectified by a specialist.

## 2.3 Nameplate

The nameplate is used to identify each electric motor. The unique motor number is clearly shown on each nameplate and is essential for internal tracking procedures. It must be possible to read the nameplate at all times. Never remove the nameplate from your motor.

**Nameplate data Motor DA 100 – 132:**

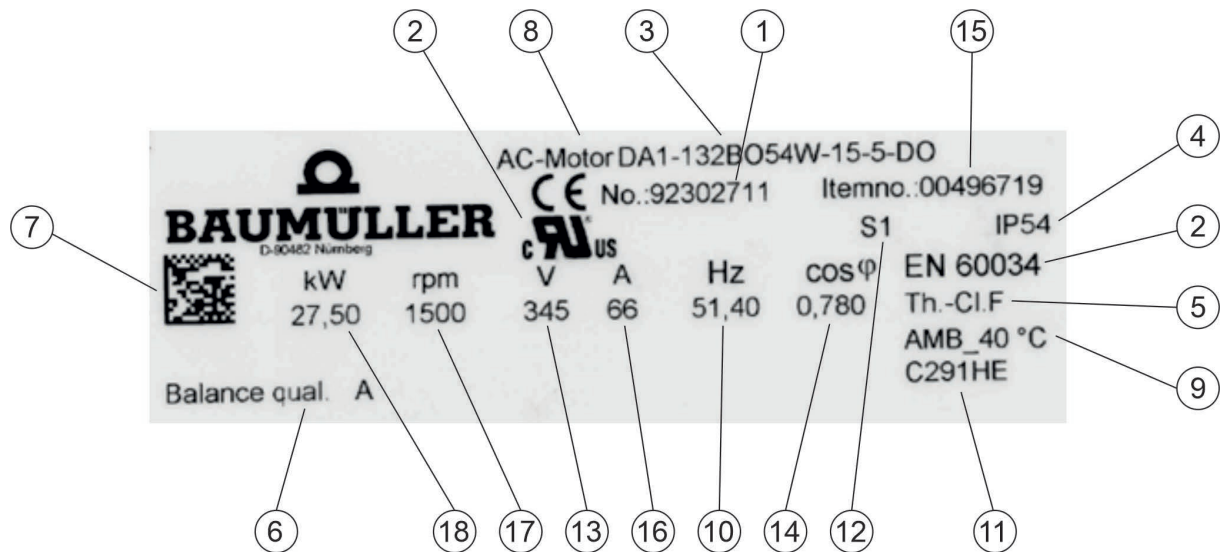

- 1 → Motor number
- 2 → Standards and approvals
- 3 → Motor type/designation
- 4 → Motor protection type
- 5 → Thermal class (VDE insulation class)
- 6 → Balance quality
- 7 → 2D code
- 8 → Motor type: 3 phase motor
- 9 → Permissible ambient temperature
- 10 → Rated frequency
- 11 → UL insulation system
- 12 → Motor operating mode
- 13 → Rated voltage  $V_r$
- 14 → Power factor  $\cos \varphi$
- 15 → Article number
- 16 → Rated current  $I_r$
- 17 → Rated speed  $n_r$
- 18 → Rated power  $P_r$

**Nameplate data Motor DA 160 – 280:**

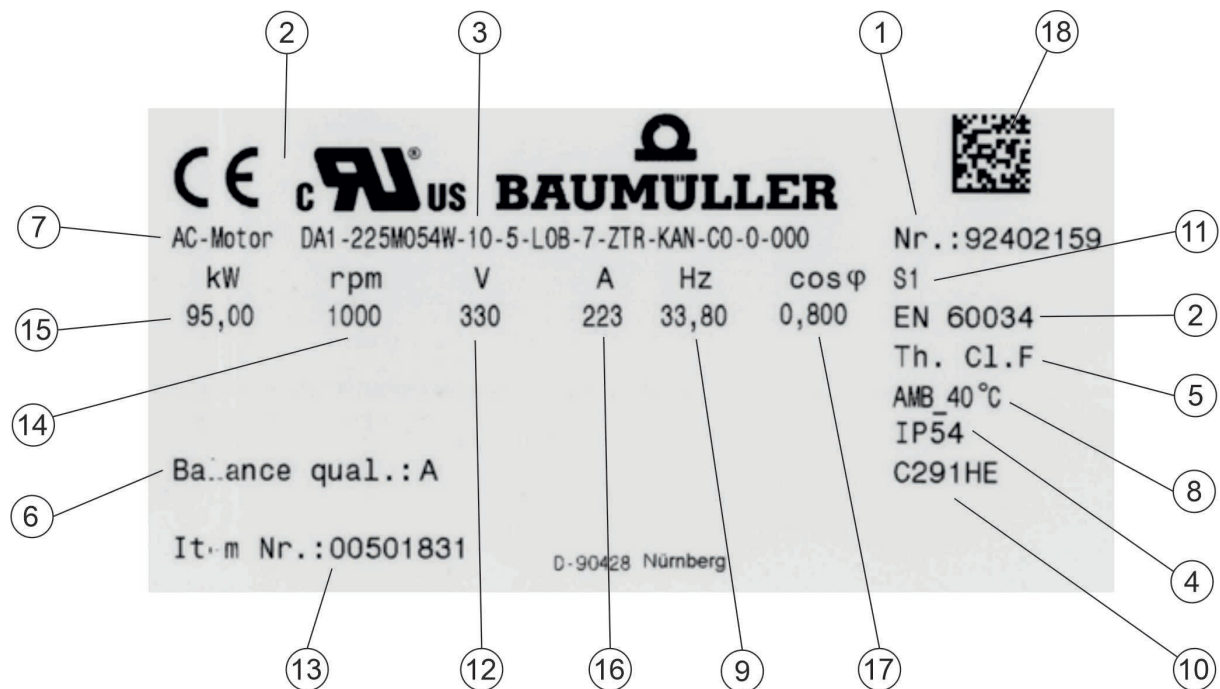

- 1 → Motor number
- 2 → Standards and approvals
- 3 → Motor type/designation
- 4 → Motor protection type
- 5 → Thermal class (VDE insulation class)
- 6 → Balance quality
- 7 → Motor type: 3 phase motor
- 8 → Permissible ambient temperature
- 9 → Rated frequency
- 10 → UL insulation system
- 11 → Motor operating mode
- 12 → Rated voltage  $V_r$
- 13 → Article number
- 14 → Rated speed  $n_r$
- 15 → Rated power  $P_r$
- 16 → Rated current  $I_r$
- 17 → Power factor  $\cos \varphi$
- 18 → 2D code

## 2.4 Technical Data

Designs (EN 60034-7)	IM B3, IM B5 (size 100 - 160) IM B3, IM B35 (size 180 - 280)
Degree of protection (EN 60034-5)	IP 54
Cooling method (EN 60034-6)	IC 3W7 (liquid-cooled)
Electrical connections (see <b>Appendix 1</b> )	
Main connection	Terminal box
Control connection	12-pin      Standard: Resolver 12 / 17-pin Option: Sincos encoder 17-pin      Option: EnDat 2.1 9-pin        Option: EnDat 2.2
Brake (optional)	Separate connection
Thermal sensor	Connection in the terminal box
Thermal motor protection (EN 60034-11)	Thermal sensor PT1000 in stator winding
Winding insulation (EN 60034-1)	Thermal class F
Ambient temperature	0°C to +40°C
Altitude (EN 60034-1)	≤ 1.000 m above sea level
Storage	-30°C...+60°C (+ 85°C, <b>comp. Section 2.5</b> )

**Note: To avoid frost damage, cooling water should be removed at temperatures < 3°C!**

Bearing	Rolling-contact bearings with long-term grease lubrication Ball bearing with re-lubrication device (DA 280.W)
Calculated bearing life	20.000 h (approximate value)
Vibration severity (EN 60034-14)	Level A (formerly N)
Shakeproof (EN 60068-2-6)	Radial 3 g (20 Hz to 55 Hz) Axial 0.5 g (20 Hz to 55 Hz)
Holding brake	Option
Speed actual value encoder	<b>Standard:</b> 2-pole resolver (higher quality version on request) Option: Sincos encoder Option: EnDat encoder

For further technical data, refer to our DA 100 - 280 technical product list online at: [www.baumueller.com](http://www.baumueller.com) under Download and Technical documentation. If necessary, you can request the corresponding documentation.

### Caution!

If the electric motor supplied is not a standard type as per the technical documentation or if special contractual arrangements have been made, there may technical differences to these Commissioning and Maintenance Instructions. In this case request the related technical supplements.

## 2.5 Transport, bearing lock, intermediate storage

### Transport:

	<p>Suitable lifting tackle must be used, e.g. belt webbing, loop belts etc. If provided, the lifting lugs of the motor can be used for lifting.</p> <p>The motor connectors are not allowed to be used for securing for transport or as lifting eyes.</p> <p>The regulations of the respective countries must be adhered to during transport. Lifting devices and transport and load suspending devices must comply with the relevant regulations.</p>
---	--

The Baumüller **DA - W** series electric motors weigh approx. **1400 kg**. Please refer to the technical documentation which accompanies the product for the exact information on weight.

The motor shaft and the connection surfaces must be protected against corrosion. The motor may only be transported with a shaft protection cover; damage to the motor shaft must be avoided.

### Bearing lock (for motors with cylinder roller bearings only):

	<p>On motors with cylinder roller bearings, the runner must be blocked at the end of the shaft in order to prevent damage during transit.</p> <p>The transport protector <b>must</b> be used every time the machine is moved.</p> <p>If this lock can no longer be used due to mounting of a drive element, other suitable means must be employed for axial fixing of the rotor for transport.</p>
---	--

### Intermediate storage:

If a motor is not to be commissioned immediately after delivery, it should be stored inside a building in a dry, dust-free and low-vibration room ( $V_{\text{eff}} \leq 0.2 \text{ mm/s}$ ).

The electric motors should be stored at as uniform a temperature as possible, not outside of the temperature range  $-15$  to  $+60 \text{ }^\circ\text{C}$ , for no more than two years. Elevated storage temperatures within the framework of the working temperature accelerate the rate at which seals and bearing grease deteriorate and therefore have a negative impact on the service life even before the unit has been commissioned. Direct exposure to incident solar radiation, UV light and ozone also lead to an ageing of the gaskets and must be avoided!

**To avoid frost damage, cooling water should be removed at temperatures  $< 3^\circ\text{C}$ .**

Please note that the warranty periods commence from the date of delivery. For this reason, we recommend that storage periods be kept to a minimum.

## 2.6 Installation conditions, cooling details

### Surroundings:

The motor can be installed indoors in dusty or damp ambient conditions and normal climatic conditions. The motor must not be brought into contact with aggressive, corrosive, abrasive or plastic-dissolving media.

Consultation with the motor manufacturer is essential in the case of installation outdoors.

For ambient conditions comp. **Section 2.4** and the technical documentation that accompanies the product.

### Cooling details:

Size	100	132	160	180	225	280
Connections VL	1	1	2	2	2	2
RL	1	1	2	2	2	2
Connecting thread	G1/2" IG	G1/2" IG	G1/4" IG	G1/4" IG	G1/4" IG	G3/8" IG
Direction of flow	as required					

### Coolant:

In accordance with Baumüller water specification (see **Appendix 2**)

The coolant (in accordance with the coolant properties specified in **Section 8.1**) is permitted to contain corrosion inhibitors and anti-bacterial additives. The type and volume of these additives is based on the respective manufacturer's recommendations and the prevailing ambient conditions.

	<p>The safety instructions provided by the manufacturer of the corrosion inhibitors and anti-bacterial additives must be observed.</p> <p>Cooling lubricants employed in manufacturing process are not allowed to be used to cool the motor!</p> <p>To prevent blockages in the coolant pipes and channels, coolants used in a sealed cooling circuit must be filtered prior to filling, in an open circuit continuously filtered (filter fineness: 0.1 mm).</p>
---	--

Note: The system manufacturer is responsible for the planning of the cooling circuit. Condensed water must not be allowed to accumulate (comp. **Section 1.2**)

## 2.7 Balancing, output elements, vibration

	<p>Do not subject the shaft or bearings to impacts.</p> <p>On mounting and dismounting output elements, it is not permitted for any axial forces to be applied to the motor.</p> <p>The generally applicable measures for the protection of output elements against physical contact are to be followed.</p> <p>If a motor is to be commissioned without output elements, measures must be taken to ensure the key is not flung out.</p>
---	--

### Balancing

In the standard design, the rotors are dynamically balanced with a half key (in accordance with DIN EN 60034-14 / ISO 8821 / ISO 1940).

**NOTE:** Observe the type of balancing as identified on the shaft end face:

**H = Balancing with half key (Standard version)**  
F = Balancing with full key (Special version)

### Output elements:

When mounting the output element, note the appropriate type of balancing.

The output elements must themselves be balanced in accordance with ISO 1940.

Suitable jigs are always to be used for fitting or removing output elements (e.g. clutch disk, gear, pulley).

- Use the threaded hole in the end of the shaft.
- When pulling, use intermediate washers to provide the shaft with mechanical protection.
- Warm up output elements if necessary before mounting (max. admissible transient temperature at shaft end 150 °C).

### Attention:

- On shaft versions without a key, the output elements are to be fastened to the output shaft **with the aid of suitable clamping sets**.
- On shaft versions with a key, it must be ensured that **the output elements rest on the shaft shoulder**. Note: The chamfer or radius on the output element and the shaft radius on the shoulder must be matched.

## Vibration:

	<p>The site vibration response of the system, which is determined by the output elements, the mounting conditions, the alignment, the installation, and the effects of external vibrations, may cause the vibration values at the motor to increase.</p> <p>In the interest of reliable motor operation and a long bearing service life, the permitted vibration values in accordance with EN 60034-14 should not be exceeded. Under certain circumstances, the rotor may need to be fully balanced with the output element (in accordance with ISO 1940).</p> <p>The vibration value after mounting must not exceed the permitted rates of acceleration (comp. <b>Section. 2.4</b> )</p> <p>Where there are deviations from normal operation – e.g., rise in temperature, noises, vibration – switch off the motor. Identify the cause and, if necessary, contact the manufacturer.</p>
---	--

## 3 Mounting

### 3.1 Safety instructions

#### Before mounting:

	<p>Never mount or commission a damaged electric motor.</p> <p>Never install the electric motor in a damaged machine.</p> <p>Before mounting the electric motor, make sure it is suitable for your machine.</p>
---	--

#### During mounting:

	<p>Only mount the motor using the fastening features provided.</p> <p>The motor should not be exposed to knocks, e.g., with a hammer, or shocks when mounting.</p> <p>Make sure that all covers and safety devices are mounted. All safety devices must comply with the latest regulations (e.g. EN 60204).</p> <p><b>Water cooling:</b></p> <p>To avoid damaging the housing, it is only allowed to use unions with a cylindrical thread for the water connections (inlet and outlet).</p> <p>The coolant pipes should not exert compression-tension forces or torsional strain on the motor connections.</p> <p>The hydraulic connection must be made by specially trained personnel. During this process the motor must be disconnected and electrically isolated.</p> <p>When coupling and uncoupling the coolant pipes, make sure that coolant does not enter the motor's terminal box.</p>
---	--

## 3.2 Installation, fixing

### Prior to and during mounting, check that

- The motor is not damaged (e.g. the shaft sealing ring must not have sustained any damage at all from sharp or pointed objects).
- The motor is not mounted in the danger zone of other equipment.
- The motor is used for the designated purpose  
*Observe nameplate details, warning labels, and signs.*
- Anti-corrosion agents have been fully removed from the shaft ends.  
*If a common solvent such as acetone or a cleaning solvent is used, it must not be allowed to wet the shaft sealing ring.*
- The motor is designed for the ambient conditions and environmental influences on site
- The compartment in the machine is suitable for the cooling method employed for the electric motor  
*The motor must be installed in such a way that the coolant lines can subsequently be connected.*
- The motor can be mounted and operated with the connection data and fastening features provided.
- The mounting dimensions of the motor and the tolerance details are provided in the technical documentation.  
*When mounting the flanges on the motor, make sure that the flange surface is in good, even contact. The supports and bearing surfaces must be clean and undamaged. They must be precisely aligned with the connecting shafts to prevent exposure of the bearings, shafts and housing to damaging loads through misalignment. When tightening the flange mounting screws (**min. strength class 8.8**), make sure that the flange connection is not distorted.*
- No liquid can penetrate the upper bearing when installing vertically with the shaft end facing upwards.
- The permitted radial forces according to the operating characteristics in the technical documentation that accompanies the product are not exceeded (if necessary, contact Baumüller for clarification).*The motor manufacturer must always be contacted if axial forces occur.*
- The brake (optional) can be released once the operating voltage has been applied (audible operating noise).
- The rotor rotates smoothly without a scraping sound.  
*On motors with a brake fitted, release the brake beforehand.*
- The design of the motor and encoder cables complies with the details in the technical documentation that accompanies the product.
- The output and input elements are secured.
- The complete cooling circuit is leak proof and fully functional



#### **Leak test acc. to EN 50178:**

The cooling system is to be checked for leaks before commissioning by pressure testing with coolant (water). The test pressure must be twice the operating pressure (minimum test pressure 1 bar). The coolant used does not have to be brought to operating temperature for this purpose. Pressure must be maintained until all areas have been tested for leaks (minimum test duration 10 minutes).



### 3.3 Electrical connections

#### Important notes:

	<p>All work must be carried out by specially trained personnel.</p> <p>Work must only be carried out when the system is electrically isolated and secured against unintentional restarting (also auxiliary circuits).</p> <p>Work must only be carried out once the motor has come to a standstill.</p> <p>Regulations for working in electrical plants must be observed!</p>
---	---

The safety regulations for work on electrotechnical systems in accordance with EN 50110-1 must be followed:

- Isolate
- Secure against unintentional restarting
- Verify safe isolation from the supply
- Earth and short
- Safeguard or cover adjacent live parts

	<p>The electric motor must be operated via a correspondingly designed converter. A direct connection to the three-phase mains can destroy the motor.</p> <p>Ensure that the phase sequence and the pin assignment are correct!</p> <p>Electrical connections, protective conductor connections, and screen connections (when using screened cables) must be permanently secure!</p>
	<p>Never touch the contacts of the encoder or thermal sensor with your hands or with tools which are or may be electrostatically charged. The encoder and the thermal sensors are electrostatically sensitive components.</p>

#### Electrical installation:

- The person setting up the system is responsible for correct electrical installation.
- The motor data on the nameplate must be observed.
- Connection cables and connectors must be correctly rated for the voltages and currents and must be suitable for the method of installation employed.
- The motor and the modules (brake and encoder etc.) must be connected in accordance with the details on the wiring diagrams (see enclosed wiring diagrams or **Appendix 1**).
- Screened power and encoder cables must be used to protect against electromagnetic EMC interference from motor cables and their effects on the encoder and control systems. Please refer to the EMC notes provided by the supplier of the converter.
- To enhance operational safety, we recommend the ready-made connection cables from Baumüller be used.
- Before connection, the plugs, sockets and the terminal boxes must be checked for damage, corrosion, dirt and dampness.
- Ensure the connections are made correctly and are tight. Seals and sealing faces on the connectors and the terminal boxes maintain the type of protection.  
**Note!** Also in the interests of safeguarding the degree of protection, the rotatable junction boxes should not be turned in their direction of connection more than 5 times altogether.
- Connectors and terminal box connections must not be exposed to mechanical stress. If necessary, protect against strain, shearing, twisting and kinking.

### In case of connection using a terminal box it is to be ensured

- The insulation is only stripped off the ends of the wires such that the insulation reaches close to the cable boot or terminal. **It is imperative that there must be no protruding wire ends.**
- The cable boots used match the dimensions and cross-sections of the terminals and wires.
- Tighten the screw connections for the electrical connections to the stipulated torque (see **Appendix 1** or technical documentation which accompanies the product)
- The type of protection is retained.

**Note:** All cable entries that are not required must be sealed with sealing elements. The sealing elements must be fully functional and undamaged when the terminal box is closed.



## 4 Commissioning, operation

### 4.1 Safety instructions

#### Working on the electric motor:

	<p>Work must not be carried out on the electric motor until the motor has come to a standstill and is electrically isolated. All connections, such as screw connections, that were loosened when working on the motor must be tightened again prior to commissioning.</p> <p>When carrying out work on the motor, please observe the technical instructions and notes in the respective sections in these Commissioning and Maintenance Instructions.</p> <p><b>Attention:</b> If the optional holding brake is fitted, it must not be used to secure anything while working on the motor (e. g. for retaining loads)!</p>
--	--



#### Risk of fatality due to electric shock:

 	<p>Make sure that the motor is disconnected and electrically isolated.</p> <p>Never disconnect the motor connections during operation.</p> <p>Only connect measuring instruments when the motor is disconnected from the power supply and electrically isolated.</p> <p>Only commence work on the motor connections when you are sure the motor is electrically isolated and there is no potential.</p> <p>When in operation, electric potential can be found at the motor terminals/contacts and at the motor windings. Never touch these modules/elements while the motor is in operation.</p>
--	--

#### Installing and uninstalling safety devices:

	<p>The electric motor must not be commissioned without first mounting the safety devices.</p> <p>The motor must be put out of operation when installing and dismantling components and systems which are provided for monitoring the motor for safe operation.</p>
---	--

### Danger on physical contact:

	Make sure that the electric motor has come to a standstill and is secured against accidental restarting before you touch it.
	Only touch the output shaft when it is electrically isolated and the motor has come to a standstill. Otherwise there is a risk due to the rotating rotor. <b>Danger of burns!</b> Never touch the motor housing when the motor is running at rated load. The surface temperatures on the motors may <b>exceed 70 °C</b> .

## 4.2 Checks prior to commissioning

- The drive is undamaged and is not located within the danger zone of other equipment.
- The motor is correctly aligned and fastened. All screwed connections are correctly tightened.
- All the appropriate safety devices (mechanical, thermal, and electrical) are mounted.
- The motor connections have been made correctly.
- The protective conductor system is correct and its functionality has been checked.
- The cables are not in contact with the surface of the motor.
- The drive is not blocked (release brake, if present).
- Emergency stop functions have been checked.
- The cooling lines have been laid correctly, the water cooling checked for function.

## 4.3 Commissioning, operation

### Note on brake function (if present):

	The brake is designed as a holding brake with an emergency stop function. (power failure and emergency stop) It must not be used as a working brake.
---	--

Commissioning must be carried out exclusively by qualified personnel.

Please refer to the commissioning instructions for the converter and the cooling system.

### Checks during commissioning:



- Release the brake, if necessary.
- Have all the modules of the motor such as the brake, encoder and cooling system etc. been checked and are they in compliance with the conditions of use?
- Have all electrical connections been made correctly and tightened? (follow wiring diagrams)
- Have all protection measures which eliminate the possibility of physical contact with live parts, hot surfaces, rotating and moving parts been followed and are these measures fully functional?
- Have all output elements been mounted and adjusted in accordance with the manufacturer's instructions?
- Are measures in place to ensure that the maximum permitted speed  $n_{max}$  of the motor cannot be exceeded? The maximum permitted speed  $n_{max}$  is the highest permitted operating speed for short-time duty.

### Checks during operation:

- Listen out for unusual noises.
- If scraping, scratching, grinding, or other similar noises occur, stop the drive immediately and locate the cause.
- Check the motor surface and connection cables for dirt, e.g. layers of dust, oil deposits, dampness and leaks etc.
- Check the maintenance intervals.

## 4.4 Malfunctions in operation

### Safety instructions:

	Troubleshooting and rectification must only be performed by qualified personnel. Do not disconnect any of the safety devices – even during test runs.
	Disconnect cooling lines when un-pressurized Only disconnect and connect electrical cables when electrically isolated and secured Observe the 5 safety rules for "Isolation" (see <b>Section 3.3</b> ).
	Beware of hot surfaces!

In case of malfunctions in operation always

- Refer to the operating instructions for the machine/system.
- Refer to the operating instructions for the converter.
- If necessary, contact the manufacturer of the motor or converter.

### Have the following information ready:

Nameplate data  
type and scope of the malfunction  
situation on occurrence of the malfunction  
application data (torque cycle, speed and forces over time; ambient conditions)

The following selection of possible causes can be helpful in the fault rectification process:

Malfunction	Cause	Remedy
Motor does not start	No controller enable Controller fault, encoder fault  Brake does not release  Faulty brake  No power supply  Rotating field	Activate controller enable Read out fault list on the converter or controller; rectify faults  Check control, connections, and power supply  Repairs carried out by manufacturer  Check connections and power supply  Check phase sequence. If necessary, switch over the connecting cables
Uneven running	Insufficient screening on connecting cables Controller parameters too high	Check screening connection and grounding Optimise controller parameters

Malfunction	Cause	Remedy
Vibrations	Coupling element or driven machine poorly balanced Inadequate alignment of the drive train Fixing screws loose	Rebalance  Realign machine set  Check and tighten screwed connections
Running noises	Foreign bodies in the motor  Bearing damage	Repairs carried out by motor manufacturer  Repairs carried out by motor manufacturer
Temperature rise in the motor Motor temperature monitoring unit trips	Drive overload  Brake does not release sufficiently: grinding brake  Water cooling not active.  Coolant supply inadequate - Filter heavily contaminated - Deposits in the cooling channels - Faults in the external cooling system	Check motor load and compare with nameplate  Have repair checked by motor manufacturer and involve him if necessary  Check and switch on if necessary  Check water circuit - Check, and clean if necessary - Check, and clean if necessary - Follow plant supplier's instructions
Overpressure in the cooling system	Heavily soiled coolant Cooling channels blocked Malfunctions in the external cooling system	Filter coolant Check and, if necessary, clean Follow plant supplier's instructions

## 5 Inspection and maintenance

### Working on the electric motor:

	<p>Work must not be carried out on the electric motor until the motor has come to a standstill, is electrically isolated, de-pressurized and has cooled down. All connections, such as screws on the motor that were loosened must be tightened again after the inspection and maintenance work.</p> <p>When carrying out work on the motor, please observe the technical instructions and notes in the respective sections in these Commissioning and Maintenance Instructions.</p> <p>When carrying out maintenance work, observe all safety instructions which also apply to the commissioning of the motor (see <b>Section. 4.1</b>).</p> <p><b>Attention:</b> if the optional holding brake is fitted, this brake must not perform a safety function during work on the motor (e.g., retaining loads)!</p>
---	---

## 5.1 Inspection

Depending on the severity of soiling on site, cleaning will have to be carried out regularly to guarantee the continuous adequate dissipation of heat. The flow rate and the pressure ratio of the cooling system must be checked.

If an optional brake is fitted, wear limits are specified (e.g., maximum permissible operating air gap, maximum number of emergency braking operations). The actual degree of wear on the brake must be checked at regular intervals. When the permissible wear limits have been reached, the brake must be replaced (see **Section 5.2**).

If an optional shaft sealing ring is used, it must be checked at regular intervals to ensure it is functioning correctly (leakage).

## 5.2 Maintenance

The service life of the bearings and sealing elements can differ greatly depending on the operating conditions, (e.g. operating mode, temperature, speed and load).

In the case of trouble-free operation, we generally recommend the following maintenance procedures:

- Replacement of the bearings after 20,000 running hours (the bearings are designed for a calculated service life of 20,000 running hours)
- Replacement of the shaft-sealing ring after approximately 5,000 running hours, if present and if no leaks have been detected during previous inspections
- Re-lubrication DA 100 - 225..W  
A note on the re-lubrication interval can be found on the motor.
- Re-lubrication DA 280..W

	1000 rpm	1500 rpm	2,000 rpm	2500 rpm	3000 rpm	Grease approx.
Ball bearing	<b>10000 h</b>	<b>5000 h</b>	<b>3000 h</b>	<b>2250 h</b>	<b>1500 h</b>	<b>75 g</b>
Roller bearing	<b>6500 h</b>	<b>3500 h</b>	<b>2000 h</b>	<b>1500 h</b>	<b>1000 h</b>	<b>75 g</b>

High temperature greases only are recommended for initial lubrication and re-lubrication, e.g. Asonic HQ 72-102 / FAG L 237.

If an optional brake is fitted, it is essential that it is replaced when its wear limits are reached.

The maintenance work is to be undertaken by Baumüller or a specialist organization authorized by Baumüller.

### Caution!

**The specifications of the technical instructions TAM 00697 must be followed during maintenance and servicing on motors which are used for safety-oriented applications.**

## 6 Disposal

The motor must be disposed of in accordance with the relevant national and local regulations within the framework of the normal recycling process.

The encoder electronics (if provided) must be disposed of in the proper manner as electronic scrap.

## 7 Appendix 1: Pole assignment (main connection and control port)

### 7.1 Main connection via the terminal box:

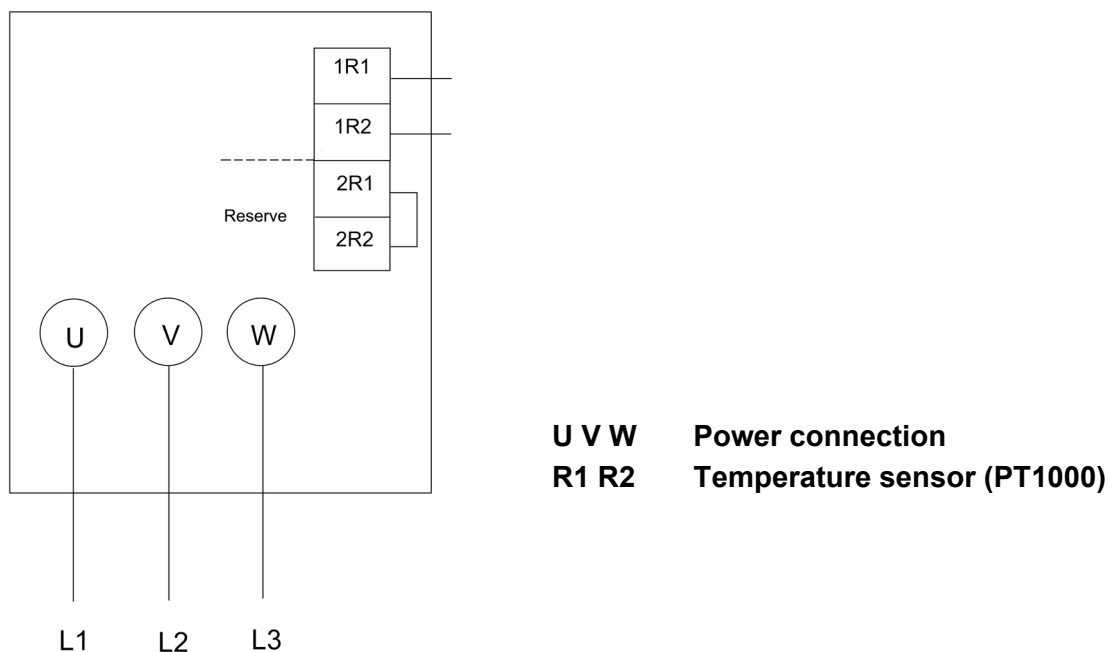

The following gives the cable entry on the terminal box and the main connection terminals with the associated torque settings.

We recommend the use of EMC cable glands for the cable glands on the cable entries.

Motor size	Cable entry	Number of main connection terminals	Tightening torque for terminals [Nm]
100	1 x M 40 + 1 x M 25	3x pluggable	-
132	1 x M 40 + 1 x M 25	3x pluggable	-
	2 x M 50 + 1 x M 25	3 x M 6	3
160	2 x M 50 + 1 x M 25	3 x M 6	3
	2 x M 63 + 1 x M 25	3 x M 10	10
180	2 x M 63 + 1 x M 25	3 x M 12	15.5
	2 x M 75* + 1 x M 25	3 x M 16	30
225	2 x M 63 + 1 x M 25	3 x M 12	15.5
	2 x M 75* + 1 x M 25	3 x M 16	30
280	after technical clarification	6 x M16	30

\* Terminal box screen laid on terminal in the terminal box.

#### **List: Terminal box versions**

Other cable entries and terminals are available on enquiry only.

## 7.2 Control port: Resolver

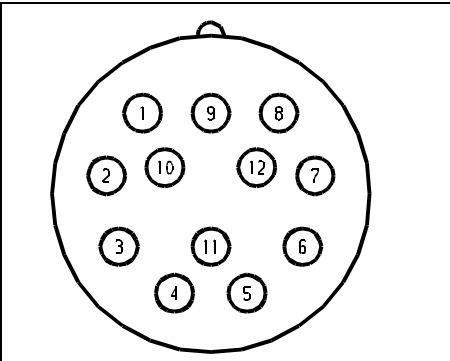
	Pin	Signal
 <p>View of the contact side of the built-in box</p>	1	cos -
	2	
	3	
	4	
	5	sin -
	6	sin +
	7	
	8	cos +
	9	
	10	Ref +
	11	
	12	Ref -

## 7.3 Control port: SRS/SRM50

(encoder with Hiperface-port from SICK / Stegmann companies)

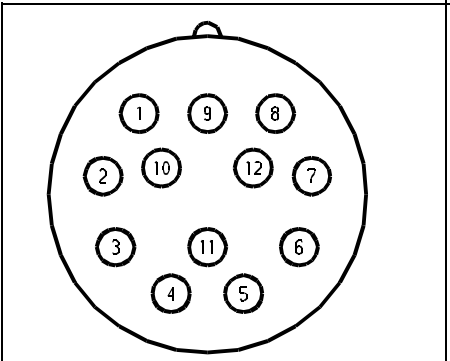
	Pin	Signal
 <p>View of contact side of the female connector</p>	1	ref cos
	2	+ 485
	3	-
	4	-
	5	sin
	6	ref sin
	7	- 485
	8	cos
	9	-
	10	Gnd
	11	-
	12	+U

#### 7.4 Control port: ECN1313 / EQN 1325 / EQN 425

(encoder with EnDat 2.1-port from Heidenhain companies)

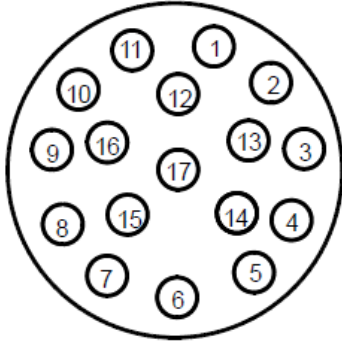
	Pin	Signal
 <p>View of contact side of the female connector</p>	1	$V_p$
	2	-
	3	-
	4	0 V
	5	-
	6	-
	7	$V_p$
	8	Clock
	9	Clock inv.
	10	0 V
	11	(Inner screen)
	12	B+
	13	B-
	14	Data
	15	A+
	16	A-
	17	Data inv.

#### 7.5 Control port: ECN1325 / EQN 1337

(encoder with EnDat 2.2-port from Heidenhain companies)

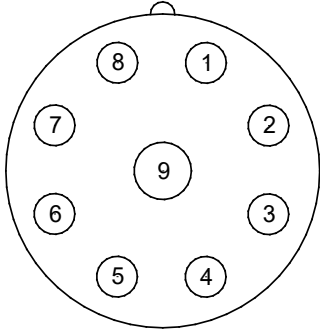
	Pin	Signal
 <p>View of contact side of the female connector</p>	1	Clock
	2	Clock inv.
	3	$V_p$
	4	0 V
	5	Data
	6	Data inv.
	7	Sensors $V_p$ :
	8	Sensor 0V
	9	-

**Note:**

- For other encoder types and optional lead for the temperature sensor via the encoder cable, see the enclosed wiring diagram or technical documentation for the pin assignment
- The encoder from Section 7.3 to 7.5 are components susceptible to ESD.

## 8 Appendix 2: Water-cooling

### 8.1 Cooling circuits

**Attention!**

Only closed and semi-open cooling circuits are permitted for engines.

**Reduction factors for water as a coolant**

Coolant inlet temperature	25 °C	30 °C	35 °C	40 °C	45 °C
Percent of list power (torque)	100 %	97 %	95 %	92 %	89 %

**Note**

In addition to water cooling, the motors can also be cooled with oil (HLP46).

Due to the lower specific heat capacity, cooling with oil leads to different reduction factors.

The reduction factors for oil-cooled motors are available on request.

**Closed cooling circuit**

In the closed cooling circuit (see figure below), the cooling water tank is closed and thus no oxygen can enter the circuit.

This ensures very low water consumption and stable water quality.

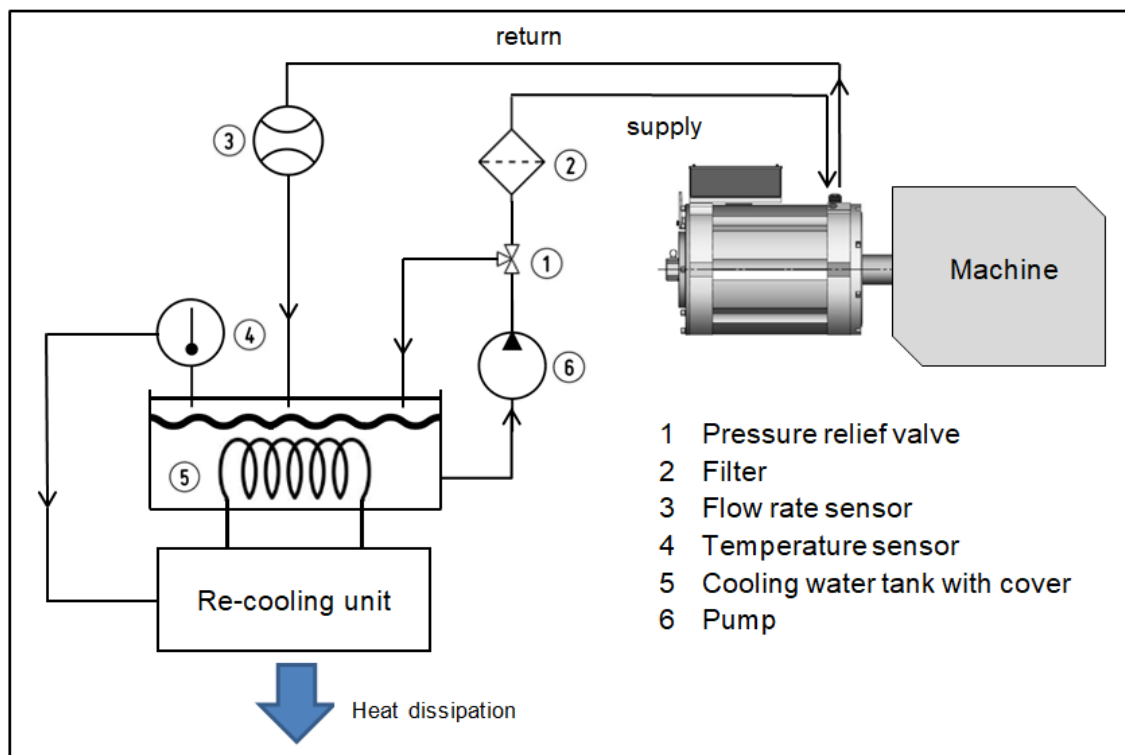

Example of a closed cooling circuit

### Semi-open cooling circuit

The semi-open cooling circuit (see figure below) has an open cooling water tank and is otherwise constructed like the closed cooling circuit.

This prevents the accumulation of corrosion products in the circuit.

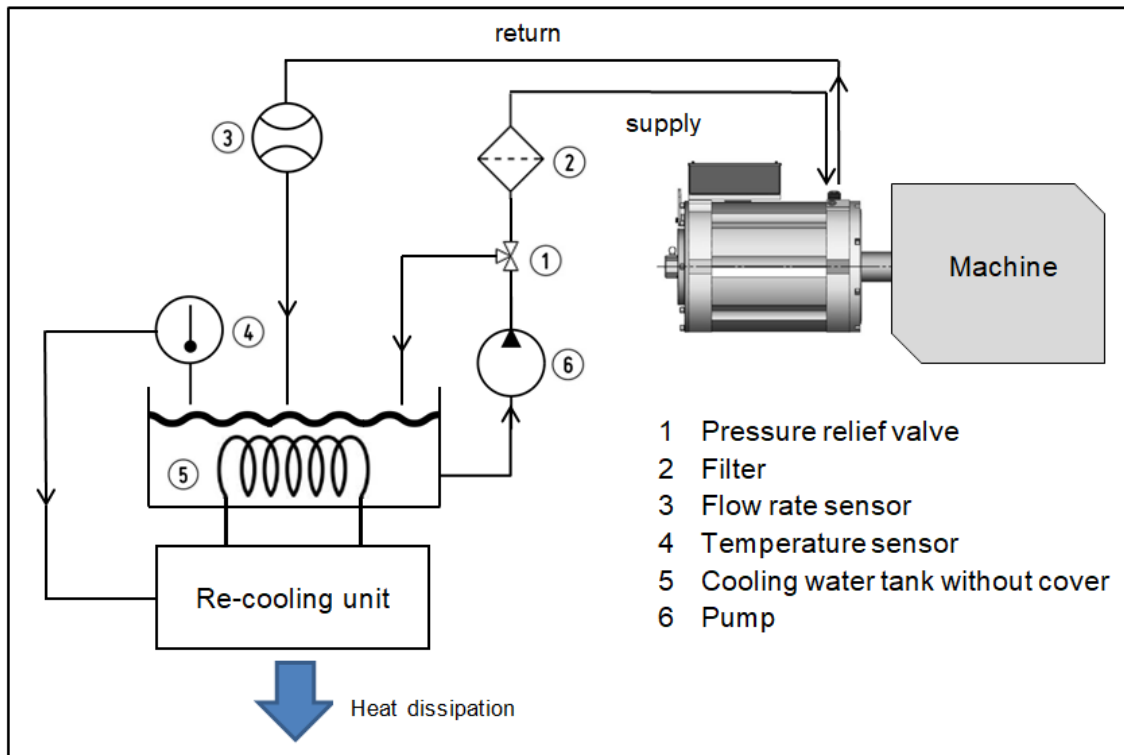

Example of a semi-open cooling circuit

### Overview of refrigeration unit manufacturers

ait-deutschland GmbH

[www.kkt-chillers.com](http://www.kkt-chillers.com)

BKW Kälte-Wärme-Versorgungstechnik GmbH

[www.bkw-kuema.de](http://www.bkw-kuema.de)

DELTA THERM Hirmer GmbH

[www.deltatherm.de](http://www.deltatherm.de)

Glen Dimplex Deutschland GmbH

[www.riedel-cooling.com](http://www.riedel-cooling.com)

Helmut Schimpke und Team Industriekühlanlagen

[www.schimpke.org](http://www.schimpke.org)

Hydac System GmbH

[www.hydac.com](http://www.hydac.com)

Hyfra Industriekühlanlagen GmbH

[www.hyfra.de](http://www.hyfra.de)

Parker Hannifin GmbH

[www.ph.parker.com](http://www.ph.parker.com)

Pfannenberg GmbH

[www.pfannenberg.com](http://www.pfannenberg.com)

Technotrans SE

[www.technotrans.de](http://www.technotrans.de)

#### Note:

You can also use equivalent cooling units from other manufacturers.

The responsibility for the quality of third-party products lies with the plant manufacturer.

## 8.2 Coolant consistency

The coolant must satisfy the following specifications:

Conditions	Unit	Value
Maximum permissible system pressure	bar	6
Temperature of coolant- for motor	°C	10 to 35
pH value (at 20 °C)	---	6.5 to 9
Overall hardness	mmol / l	1.43 to 2.5
Chloride - Cl-	mg / l	< 200
Sulfate - SO <sub>4</sub> <sup>2-</sup>	mg / l	< 200
Oil	mg / l	< 1
Permissible particle size of solid foreign objects, particles (e.g., sand)	mm	< 0.1

Clean water that is free of dirt and suspended matter must be used as a coolant.

### Note:

For standstill of motor for longer time the cooling must be stopped (to avoid condensation).

If ambient temperatures of < 3° C may occur during a longer motor standstill, coolant should be discharged as a precaution (to prevent frost damage).

## 8.3 Required coolant volume flows

The following amounts of coolant are necessary to cool the motors

DA size	100	132	160	180	225	280
Flow rate in l/min (min.)	7 (5)	9 (6,5)	11 (9)	12 (10)	13 (11)	17 (14,5)
Pressure drop in bar	0,29±10 %	0,33±10%	1,05±10%	1,35±10%	2,55±10%	2,55±10%
Temperature rise in K (max.)	6 (9)	7 (10)	8 (10)	10 (12)	11 (13)	11 (13)
Max. coolant pressure in bar	5	5	5	5	5	6

### *Warranty and liability*

All the details in this documentation are non-binding customer information and subject to ongoing change and will be constantly updated by our editing staff. Warranty and liability claims against Baumüller Nürnberg GmbH are excluded if, in particular, damage is caused by one or more of the following:

- You have not followed the instructions in this documentation.
- You have not used the system for the purpose intended.
- You have
  - installed, connected, started or operated the machine incorrectly or have not maintained it
  - permitted the system to be mounted, connected, commissioned, operated, and/or maintained by unqualified or insufficiently qualified personnel.
  - overloaded the system.
  - operated the system with
    - faulty safety devices,
    - safety devices that were incorrectly fitted or not fitted,
    - safety devices or protective devices that are not in working order.
  - Not operated the system in the stipulated ambient conditions
- You have modified the system without the written approval of Baumüller Nürnberg GmbH.
- You have not observed the instructions concerning maintenance in the component descriptions.
- You have not monitored parts that are subject to wear sufficiently.
- You have performed a repair incorrectly.
- You have combined the system with products from other manufacturers in an improper manner.
- You have combined the drive system with faulty and/or incorrectly documented products from another manufacturer.

The latest version of the General Terms and Conditions of Sale of Baumüller Nürnberg GmbH always apply.

These will be made available to you at the latest on conclusion of the contract.