

Commissioning and Maintenance Instructions

be in motion be in motion



TAM 00609

DA 100 – 280

Three-phase asynchronous
motor

Air-cooled

Version: 03/2015

English

LEGAL NOTES ON DOCUMENTATION

Copyright

This documentation is only permitted to be copied by the owner for internal use. As many copies as required may be made. For other purposes, this documentation may not be copied or duplicated either in whole or in part. Utilization and provision of the contents to third parties is not allowed. Names and company logos in this documentation may be trademarks, which, if used by third parties for their own purposes, may result in infringements of the rights of the owner.

Applicability

This documentation is part of the unit/the machine. These Commissioning and Maintenance Instructions must be available to the operator at all times and be in a readable condition.

On the sale/storage of the unit/machine, this documentation must be passed on together with the unit/machine by the owner. Following the sale of the unit/machine, this original and all copies are to be passed on to the purchaser. Following disposal or any other form of termination of utilization, this original and all copies are to be destroyed.

With the introduction of this documentation, earlier issues of are superseded.

Please note that the details/figures/information represent **current values at the time of going to press**. These details are **not legally binding** for the purpose dimensioning, computation and calculation.

Baumüller Nürnberg GmbH reserves the right to change the technical data and the method of operation of Baumüller products in the context of the further development of the products.

No liability can be accepted concerning the correctness of the product information unless otherwise specified in the General Conditions of Sale and Delivery.

BAUMÜLLER NÜRNBERG GmbH

Motor Division
D-90482 Nuremberg

www.baumueller.de

Content

- 1. General Safety Instructions4**
 - 1.1 Safety4
 - 1.2 Designated use.....5
 - 1.3 Prohibition of unauthorized modifications and changes6
- 2 Operating conditions6**
 - 2.1 Product description6
 - 2.2 Scope of supplies6
 - 2.3 Type plate7
 - 2.4 Technical data9
 - 2.5 Transport, intermediate storage10
 - 2.6 Installation conditions, cooling details11
 - 2.7 Balancing, vibrations11
- 3 Mounting.....12**
 - 3.1 Safety instructions12
 - 3.2 Installation, fixing12
 - 3.3 Electrical connection13
- 4 Commissioning, operation15**
 - 4.1 Safety instructions15
 - 4.2 Tests prior to commissioning16
 - 4.3 Commissioning, operation16
 - 4.4 Malfunctions17
- 5 Inspection and maintenance18**
 - 5.1 Inspection18
 - 5.2 Maintenance19
- 6 Disposal.....19**
- 7 Appendix 120**
 - 7.1 Main connection / terminal block designation:20
 - 7.2 Encoder connection21
 - 7.2.1 Resolver (standard design) – Pin assignment21
 - 7.2.2 Sincos-encoder SRS/SRM50 (Fa. SICK / Stegmann) – Pin assignment21
 - 7.2.3 Sincos-encoder ECN1313 / EQN 1325 / EQN 425 (Heidenhain) EnDat 2.1– Pin assignment22
 - 7.2.4 Encoder ECN1325 / EQN 1337 (Heidenhain) Endat 2.2 – Pin assignment (M23)23
 - 7.3 Fan connection / terminal designation24

1. General Safety Instructions

1.1 Safety

This electric motor has been constructed in accordance with the relevant safety standards and underwent an operational safety check before leaving our factory.

To ensure correct commissioning and safe use, please read the following:

- These Commissioning and Maintenance Instructions
- The safety and commissioning notes
- The technical documentation that accompanies the product
- The commissioning and safety notes provided by the manufacturer of the converter
- The national, local and system-specific regulations concerning your finished product.

We draw your attention to the following hazards when using the product:

- Hazards resulting from
- lifting and transport processes
 - electrical current
 - moving parts
 - hot surfaces
 - EMC disturbances
 - mechanical overloads
 - thermal overload

To avoid damages to persons and property and minimize residual risks, please read all of the safety instructions and, in particular, those that are marked with a symbol.



Danger to life due to electrical shock

Non-observance can lead to death or a grave injury.



Warning concerning general dangers

Non-observance can lead to serious injury or damage to assets.



Warning concerning dangerous situation

Non-observance can lead to damage of system or peripheral equipment.



Do not touch!

Non-observance can lead to serious injury.



Unpermitted action

Non-observance can lead to serious injury.



Warning concerning hot surface

Non-observance can lead to serious injury.



Electrostatically sensitive components

Non-observance can cause damage to the plant or the environment.

1.2 Designated use

The electric motor must only be used for its designated purpose. In this context, the electric motor must only be used for the applications described in this technical documentation under strict observance of all the notes in these Commissioning and Maintenance Instructions.

All assembly, commissioning, maintenance and operating tasks must be carried out by qualified personnel only.

Within the context of these safety instructions, qualified personnel refers to persons who are trained and authorized in the specialized area, who are authorized to set up, assemble, commission and operate devices, systems and circuits under application of the applicable safety standards (EN 50110-1).

Inappropriate action can cause serious damage to persons and property.

The electric motor is designed for use in industrial applications and is subject to the following standards and directives:

Standards

EN 60034-1, EN 60034-5, EN 60034-6, EN 60034-7, EN 60034-9, EN 60034-11, EN 60034-14, EN 60204-1

Low Voltage Directive 2006/95/EG

The electric motors in this series comply with the requirements of the Low Voltage Directive 2006/95/EG (conformity).

Machinery Directive 2006/42/EG

Electric motors are components to be installed in machines for installation in machines defined in the Machinery Directive. Commissioning is not permitted until the conformity of the finished product with this directive has been established (refer to EN 60204-1 "Electrical Equipment of Machines").

EMC Directive 2004/108/EG

The operation of the electric motor in its intended use must comply with the protective requirements laid down in the EMC Directive 2004/108/EG. The person setting up the system is responsible for the correct installation (such as spatial isolation of signal lines and power cables, screened lines and cables etc.). In the case of systems with converters, the EMC notes of the manufacturer of the converter must also be observed.

All national, local and system-specific regulations must also be observed

The electric motor is designed for the following ambient conditions:

- Ambient temperature: 0 °C to +40 °C
- Installation height: ≤1,000 M ASL
- Relative humidity: 10 % to 80 %

Condensation water must not be allowed to accumulate.

Please take note of any deviating details specified on the type plate or in the technical documentation. The conditions at the place of utilization must correspond to the details on the rating plate



Utilization in hazardous areas is **prohibited**, unless the unit is designed for this purpose (refer to additional notes). Furthermore, the area surrounding the electric motor must be free of inflammable gas mixtures and concentrations of dust. Live and hot motor parts are inflammable and may cause serious injury and damage to property.

If, in special cases, greater requirements are placed – for utilization in non-industrial applications – (such as protection against contact with a child's fingers), these conditions must be by the customer met when installing the system.

Thermal hazards:

	<p>Caution! Highly inflammable!</p> <p>Temperatures of over 70°C can build up on the motor surfaces. Touch contact measures must be implemented if necessary!</p> <p>Temperature-sensitive parts, such as normal cables or electronic components, must not be placed on or fixed to the hot surfaces.</p> <p>Thermal overloading can destroy the winding and the bearing. A thermal sensor should be used to monitor the temperature.</p>
---	---

1.3 Prohibition of unauthorized modifications and changes

	<p>For safety reasons, unauthorized modifications and changes to the electric motor are not permitted. If such modifications / changes are necessary, please contact the motor manufacturer.</p> <p>No safety devices may be dismantled or decommissioned prior to the operation of the device.</p>
---	---

2 Operating conditions

2.1 Product description

Electric motors of the series „DA...“ are 4-pin, air-cooled three-phase asynchronous motors. This optimized forced ventilation assures an efficient cooling which allows a high torque and power density at a high enclosure (such as IP54).

When operated at a motor-controlled converter these rugged motors can be controlled dynamically in speed and position and are ideally suited for applications in machine tools and manufacturing machines.

2.2 Scope of supplies

The delivery is put together on an order-related basis.

- The carrier must immediately be notified of any damage caused during transport.
- On delivery, please check that the ratings and motor type correspond with the order data. In the event of apparent defects or incomplete delivery, the appropriate Baumüller office or the Baumüller head office in Nuremberg should be notified immediately.

In both of the above cases, commissioning may not be made until the error has been fixed correctly.

2.3 Type plate

The type plate is used to identify each electric motor. In particular, the accordant motor number is unique for each electric motor and essential for internal tracking procedures. It must be possible to read the type plate at all times. Never remove the type plate from your motor.

Type plate data of the DA 100 – 132 motor:

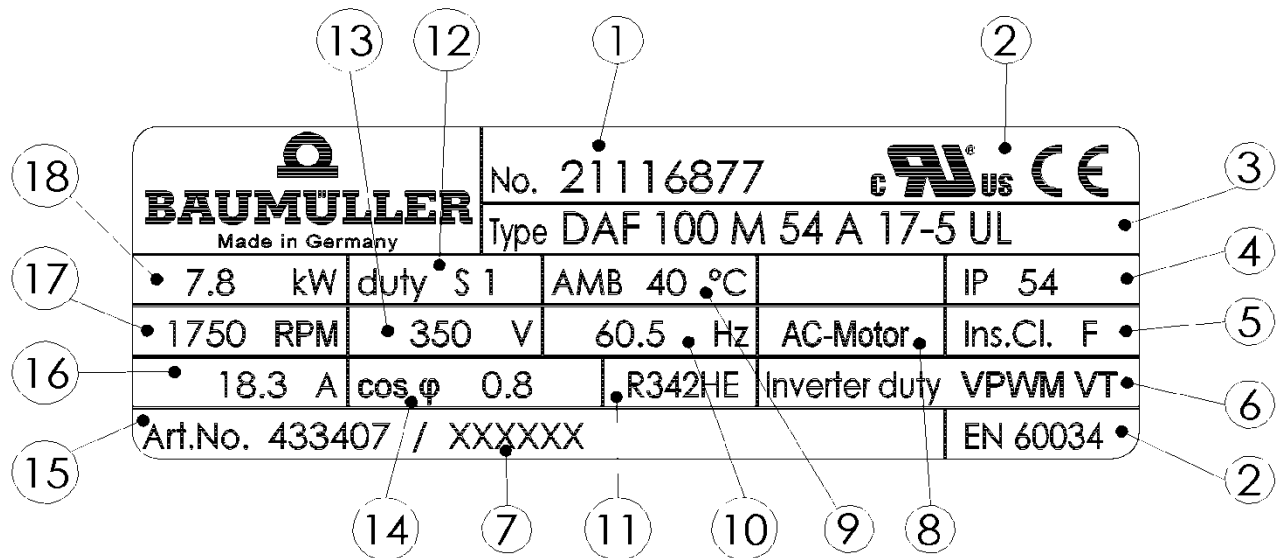

- 1 → Motor number
- 2 → Standards and licenses
- 3 → Motor type / designation
- 4 → Motor-type of protection
- 5 → Thermal class (insulation material class designation VDE)
- 6 → Motor is operated with a converter
- 7 → (optional) part number of customer
- 8 → Motor type: 3 phase motor
- 9 → Permitted ambient temperature
- 10 → Rated frequency
- 11 → Insulation system UL
- 12 → Motor-operation type
- 13 → Rated voltage U_N
- 14 → Power factor $\cos \varphi$
- 15 → Part number
- 16 → Rated current I_N
- 17 → Rated speed n_N
- 18 → Rated power P_N

Type plate data of DA 160 – 280 motor:

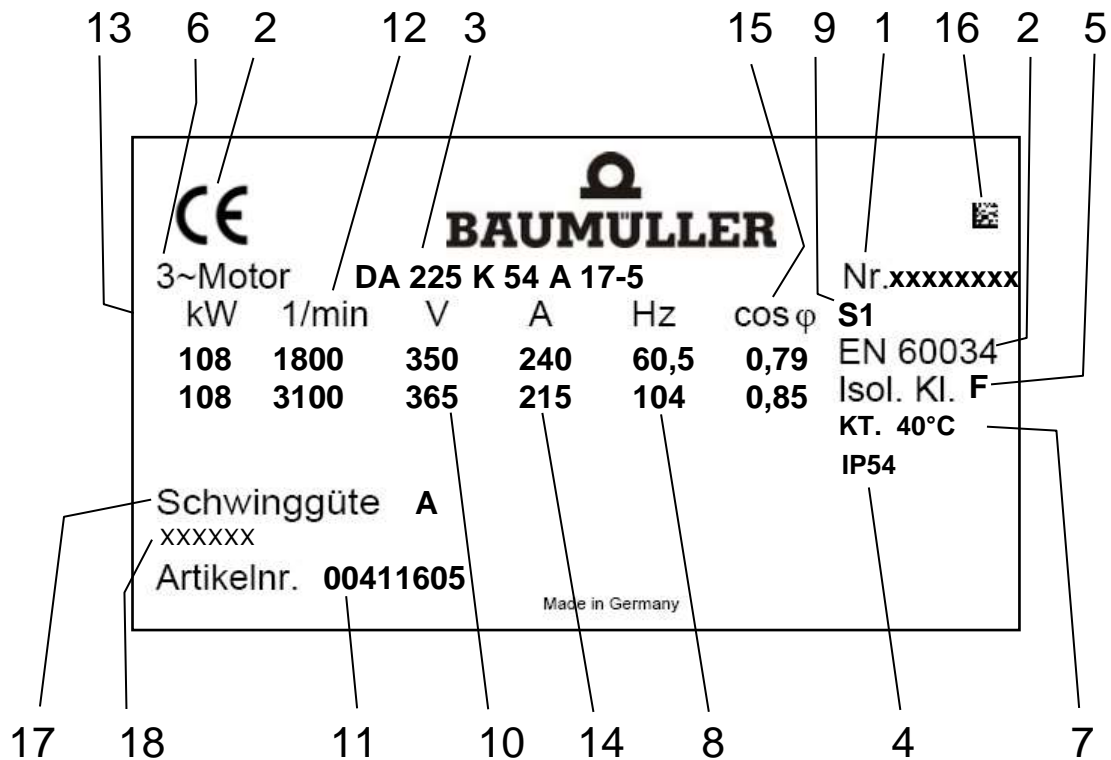

- 1 → Motor number
- 2 → Standards and licenses
- 3 → Motor type / designation
- 4 → Motor type of protection
- 5 → Thermal class (insulation material class designation VDE)
- 6 → Motor type: Three-phase motor
- 7 → Allowed ambient temperature
- 8 → Rated frequency
- 9 → Motor operation mode
- 10 → Rated voltage U_N
- 11 → Part number
- 12 → Rated speed n_N
- 13 → Rated power P_N
- 14 → Rated current I_N
- 15 → Power factor $\cos \varphi$
- 16 → 2D-Code
- 17 → Vibration class
- 18 → (optional) part number of customer

2.4 Technical data

Designs (EN 60034-7)	IM B3, IM B5 size 100 / 132 / 160
	IM B3, IM B35 size 180 / 225 / 280)
Type of protection (EN 60034-5)	IP23 internally cooled, with fan
	IP54 surface-cooled, with fan
Forced ventilation	
DA100	Standard: Axial fan at non-drive end, built-in fan motor ¹⁾ ; direction of air flow from drive end to non-drive end, air outlet opening is axial at non-drive end
DA132 - DA 225	Standard: Axial fan at non-drive end; added-on standard motor, direction of air flow from drive end to non-drive end, air outlet opening lateral, non-drive end
	Option 1: Axial fan at non-drive end; built-in fan motor ¹⁾ direction of air flow from drive end to non-drive end, air outlet opening is lateral, non-drive end
	Option 2: Radial fan at non-drive end; added-on standard motor, direction of air flow from non-drive end to drive end, air outlet opening lateral drive end
DA 280	Radial fan on the non-drive end, added standard motor, air direction from non-drive end to drive-end
	Air outlet opening lateral on drive end
	¹⁾ CAUTION! Not permitted for flammable, explosive, chemically aggressive or electrically well conductive dusts.
Cooling method (EN 60034-6)	IP 23 IC 06 internally cooled motor
	IP 54 IC 0641 surface-cooled motor
Electrical connections (refer to Appendix 1)	
Main connection	Terminal box
Control connection	Resolver – 12 pin connector, 17 pin connector at the ENDAT interface
Fan / built-in fan motor	6-pin connector (unit DA 100)
Fan / added-on standard motor	Terminal box, standard motor (unit DA 132 -280)
Brake (optional)	Separate connection
Thermal sensor	Connection in terminal box
Thermal motor protection (EN60034-11)	Thermal sensor KTY84 in stator winding
Winding insulation (EN 60034-1)	Insulation class F
Ambient temperature	0°C ... +40°C
Installation altitude (EN 60034-1)	≤ 1.000 M ASL
Storage	-30 °C...+60 °C (+ 85 °C, refer to chapter 2.5)
Bearing	Roller bearing with permanent lubrication (DA 100 - 225) or with a relubricating device (DA 280) (refer to chapter 5.2)
Computed operational life	20.000 h (approximate value)
Amplitude of vibration (EN 60034-14)	Level A (formerly N); optional B

Vibration-proof DA100	radial 0,5 g/axial 0,5 g, 10 Hz - 150 Hz (acc. to EN 60068-2-6)
Vibration proof DA132 - DA280 to	radial 3 g/axial 1 g, 10 Hz - 55 Hz (acc. to EN 60068-2-6)
Holding brake	Option
Actual speed encoder	Standard: 2-pin resolver Option: Sincos encoder

For further technical values, please refer to our technical product list DA 100 - 280 on the website of www.baumueller.de in the download area – technical documents. Please, contact us for the accordant documents, if required.

CAUTION!

If the electric motor supplied is not a standard version in accordance with the technical documentation or if special arrangements were contractually agreed, the technical data may differ to the values stated in these Commissioning and Maintenance Instructions. The supplementary technical details are available on request.

2.5 Transport, intermediate storage

Transport:

	<p>Suitable load suspension material must be used, such as belt webbing, loop belts etc. If provided, the lifting lugs of the motor can be used for lifting.</p> <p>The terminal boxes or motor connectors must not be used as shipping braces or lifting lugs.</p> <p>The regulations in the respective countries must be adhered to during transport. Lifting devices, transport and load suspending devices must comply with the regulations.</p>
--	--

The Baumüller electric motors of the “DA...” series weigh up to approx. **1,400 kg**. Precise details relating to the weight of the respective devices can be found in the technical documentation.

The motor shaft and the connection surfaces must be protected against corrosion. The motor must be transported with motor shaft covering to prevent unnecessary damage to the motor shaft.

Air inlet and outlet openings must be covered to prevent any foreign matter ingress into the fan during transport.

Bearing security (at motors with cylindrical roller bearings only)

	<p>In order to avoid transportation damages the motors with cylindrical roller bearing of the rotors are blocked by means of transport safety devices at the shaft end.</p> <p>For further transports this transport safety must be used again.</p> <p>In case this safety device cannot be used anymore due to the addition of a drive element then other suitable measures must be made to fix the axes of the rotor during the transport.</p>
---	--

Intermediate storage:

If a motor is not to be commissioned immediately after delivery, it should be stored inside a building in a dry, dust-free and low-vibration room ($V_{\text{eff}} = 0.2\text{mm/s}$).

The electric motors should not be stored for more than two years at a preferably constant temperature between -30°C to $+60^{\circ}\text{C}$. Higher storage temperatures within the service temperature will accelerate the ageing of gaskets and the bearing greases and therefore affect the service life already before the commissioning negatively. Direct exposure to incident solar radiation, UV light and ozone can also lead to an ageing of the gaskets and must be avoided!

Please note that the warranty periods commence from the date of delivery. For this reason, we recommend that storage periods be reduced to a minimum.

2.6 Installation conditions, cooling details

Surroundings:

The motor can be installed in roofed over rooms with dusty or damp ambient conditions and normal climatic conditions. In general, the motor may not be brought into contact with aggressive, corrosive, abrasive or plastic-dissolving solutions. Dust filters with micro-filter mats must be interposed where air containing dust particles are used as cooling air.

The warmed-up motor exhaust air – even of adjacent units – must not be taken in again.

Consultation with the motor manufacturer is essential in the case of outside installation.

For ambient conditions refer to **chapter 2.4** and the technical documentation that comes with the product.

Information on required cooling quantities

The following approximate air quantities are required to cool the DA motors.

DA frame size	100	132	160	180	225	280
Air quantity in m ³ /min	2.5	5.8	9.5	16.5	23	35
Pressure level in Pa	180	360	630	850	950	1900

2.7 Balancing, vibrations



The shaft and bearing must not be exposed to knocks.
No axial forces are permitted when mounting or dismounting the output elements.
The generally required measures to prevent contact with the output elements must be observed.
If the motor is commissioned without the output element, the featherkey must be secured to ensure that it is not thrown out.

Balancing:

In the standard version, the rotors are balanced dynamically with half the featherkey inserted.

(In accordance with DIN EN 60034-14 / ISO 1940)

NOTE: The balancing method is marked on the shaft end face:
H = Balancing with half featherkey - standard version
F = Balancing with full featherkey - special version

Output elements:

When assembling the output element, make sure that the correct balancing method is used. The output elements must be balanced in accordance with ISO 1940.

Suitable devices should always be used to push on or pull off the output elements (e.g. coupler disk, gear wheel or belt pulley).

- Use tapped hole at end of shaft.
- When pulling off, use spacer washer for mechanical protection of shaft.
- If necessary, heat the output element (max. permitted temperature at the shaft end 150°C).

CAUTION:

If the shaft does not have a featherkey, the output elements are fixed to the drive shaft using **appropriate clamping bushes**.

- In the case of shafts with a featherkey, make sure that the output elements are fitting **the shoulder of the shaft**. Note: The chamfer or radius at the output element and the shaft radius at the shoulder have to be harmonized.

Vibrations:

	<p>The vibration behavior of the system, which is determined by the output elements, the mounting conditions, the alignment, the installation and the effects of external vibrations, may cause the vibration values at the motor to increase.</p> <p>In the interest of reliable motor operation and a long bearing service life, the permitted vibration values in accordance with EN 60034-14 are not supposed to be exceeded. Under certain circumstances, the rotor may need to be fully balanced with the output element (in accordance with ISO 1940).</p> <p>The simulated vibration values after assembly must not exceed the permitted rates of acceleration (refer to chapter 2.4)</p> <p>If there are deviations from normal operation – such as rise in temperature, noises, vibrations – disable the motor in case of doubt. Identify the cause and contact the manufacturer, if necessary,</p>
---	--

3 Mounting

3.1 Safety instructions

Prior to mounting:

	<p>Never mount or commission a damaged electric motor.</p> <p>Never install the electric motor in a damaged machine.</p> <p>Before mounting the electric motor, make sure that it is suitable for your machine.</p>
--	---

During the mounting:

	<p>Only mount the motor on the fixing options provided.</p> <p>The motor should not be exposed to knocks such as with a hammer, or shocks when mounting.</p> <p>Make sure that all covers and safety devices are mounted. All safety devices must comply with the latest regulations (refer to EN 60204).</p> <p>Air cooling:</p> <p>Protective covers must be attached to the air inlet and outlet openings where there is a possibility during operation of foreign matter falling into the fan.</p>
---	---

3.2 Installation, fixing

Prior to and during mounting, check the following:

- The motor is not damaged (e.g. the shaft sealing ring should not be damaged in any way by sharp objects).
- The motor is not mounted in the danger zone of other facilities.
- The motor is used for the intended purpose.
(observe type plate details, warning labels and signs.)
- Anti-corrosive agents are fully removed from the shaft ends.
When using standard solvents such as acetone or benzine, the shaft sealing ring must not be moistened!
- The motor is designed for the ambient conditions and environmental influences on site.
- The space in the machine is suitable for the cooling method employed by the electric motor.
The motor must be installed in such a way that the coolant lines can subsequently be connected.
- The motor can be mounted and operated with the connection data and fixing possibilities provided.
The mounting dimensions of the motor and the tolerance details are provided in the technical documentation.
When mounting the flanges on the motor, make sure that the flange surface rests well and evenly. The supports and bearing surface must be clean and undamaged. They must be precisely aligned with the connecting shafts to prevent the bearing, shafts and housing being exposed to damaging loads through

misalignment. When tightening the flange fixing screws, (min. property class 8.8) make sure that the flange connection is not twisted.

- No liquid can enter the upper bearing when installing vertically with the shaft end facing upwards.
- The permitted radial forces in accordance with the operating characteristics in the technical documentation are not exceeded. If necessary, contact Baumüller. The motor manufacturer must always be contacted in the case of axial forces.
- The brake (optional) can be released after feeding the operating voltage (audible switching noise).
- The rotor rotates smoothly without making a scraping sound.
If the motor is equipped with a brake, the brake should be released previously.
- The design of the motor and encoder cables complies with the details in the technical documentation.
- The output and input elements are secured.
- The cooling system is functional and protected against any foreign matter that might fall into it
- There is sufficient free space for filter replacement.



3.3 Electrical connection

Important notes:

	<p>All work must be carried out by specially trained personnel.</p> <p>Work must only be carried out when the system has been de-energized and secured against unintentional restarting (also auxiliary circuits).</p> <p>Work may only be carried out once the machine has come to a standstill.</p> <p>Regulations for working in electrical plants must be adhered to!</p>
---	---

The safety regulations for work in electrotechnical plants in accordance with EN 50110-1 (DIN VDE 0105-100) must be observed:

- Disconnect the system
- Secure against unintentional restarting
- Verify safe isolation from supply
- Carry out earthing and short-circuiting
- Safeguard or cover adjacent live parts

 	<p>The electric motor must be operated via a correspondingly designed converter. The direct connection to the three-phase supply can result in a destruction of the motor</p> <p>Ensure that the phase sequence and the pin assignment are correct!</p> <p>Electrical connections, protective conductor connections and screening connections (when using screened cables) must be permanently safe!</p> <p>Never touch the contacts of the encoder or thermal sensors with your hands or with tools that are electrostatically charged. The encoder and the thermal sensor are electrostatically endangered components.</p>
--	--

Electrical installation:

- The supplier of the system is responsible for the correct electrical installation.
- The motor data on the type plate must be observed.
- Connection cables and plug connections must be checked for any occurring voltages and current intensity and must be suitable for the method of installation employed.
- The motor and the modules (brake, encoder, fan etc.) must be connected in accordance with the details in the wiring diagrams (refer to the enclosed wiring diagrams / **appendix 1**).
- Screened power and encoder cables must be used to protect against electromagnetic EMC interference from motor cables and their effect on the encoder and control system. Please refer to the EMC notes provided by the supplier of the converter.
- To enhance operational safety, we recommend that the ready-made connection cables of Baumüller are used.
- Prior to connection, the female connectors, connectors and terminal box must be checked for damage, corrosion, dirt and dampness.

- Make sure that the screwed connections are correct and tight. Check gaskets and sealing surfaces of connectors and terminal boxes to guarantee protection type.
Note! To protect the degree of protection the rotatable outlets ought to be not more than 5°x turned towards their connection direction.
- Connectors and terminal box connections must not be exposed to mechanical stress. If necessary, provide strain, shearing, twist and bend protection.

When the power cable is connected via the terminal box, make sure that

- the cable ends are stripped only insofar that the insulation extends up to the cable lugs or terminals. Absolutely avoid protruding wire ends.
- the cable lugs that are used are suitable for the dimensions and cross-sections of the terminals and cables.
- the screwed electrical connections are tightened in accordance with the specified tightening torque. (refer to **appendix 1** and technical documentation on the product)
- the protection type is maintained.

Note: All lead-ins that are not used must be closed off with the sealing caps. The sealing elements must be fully functional and undamaged when closing the terminal box.



4 Commissioning, operation

4.1 Safety instructions

Working on the electric motor:

	<p>Work must not be carried out on the electric motor until the motor has come to a standstill and is de-energized. All connections, such as screw connections, that were loosened must be tightened again prior to commissioning.</p> <p>When carrying out work on the motor, please observe the technical instructions and notes in the respective chapters in these Commissioning and Maintenance Instructions.</p> <p>CAUTION!</p> <p>An optional integrated holding brake may not take up a safety position during the works at the motor (such as holding loads).</p>
---	--



Danger to life due to electrical shock:

 	<p>Make sure that the motor is disconnected and de-energized.</p> <p>Never disconnect the motor connections while in operation.</p> <p>Only connect measuring device when motor is disconnected from power supply and de-energized.</p> <p>Only commence work on the motor connections after you are sure that the motor is de-energized and that there is no electric potential.</p> <p>During operation, electric potential can be found at the motor terminals/contacts and at the motor windings. Never touch these modules/elements while the motor is in operation.</p>
---	---

Mounting and demounting the safety devices:

	<p>The electric motor may not be mounted without mounting the safety devices at first.</p> <p>In order to mount and demount components and systems intended to monitor the safety motor operation the motor at first must be put out of operation.</p>
---	--

Danger when touched:

 	<p>Make sure that the electric motor has come to a standstill and is secured against accidental restarting before you touch it.</p> <p>Touch the output shaft, only if it is free from tension and has come to a standstill. Otherwise, danger due to a rotating rotor.</p> <p>Danger of burns! Never touch the motor housing when motor is running at rated load. Surface temperatures can rise up to 70°C.</p>
--	---

4.2 Tests prior to commissioning

The drive is undamaged and is not located within the danger zone of other equipment

- The motor is correctly aligned and fixed. All screwed connections are correctly tightened.
- All the appropriate safety devices (mechanical, thermal and electrical) are mounted.
- The motor connections have been carried out correctly.
- The protective conductor system is correct and its functionality has been checked.
- The lines and cables do not come into contact with the motor surface.
- The drive does not block (release brake, if applicable).
- Emergency OFF functions have been checked.
- The fan has been properly connected and its functioning checked.
- The direction of fan wheel rotation is identical to the identified direction of arrow.

4.3 Commissioning, operation

Notes on the brake function (if provided):

	<p>The brake is a holding brake with an emergency STOP function (power failure, emergency stop)</p> <p>The brake may not be used as a working brake.</p>
---	--

The commissioning must be carried out by qualified personnel, only.

Please refer to the commissioning instructions for the converter.

Tests during commissioning:

- Release brake if required.
- Has the functionality of all motor modules such as the brake, encoder, cooling system been checked and are the operating conditions observed?
- Have all electrical connections been carried out and fixed as required by the regulations (refer to wiring diagrams)?
- Have all protection measures that eliminate the possibility of contact with live parts, hot surfaces, rotating and moving parts been observed and are these measures fully functional?
- Have all output elements been mounted and set in accordance with the manufacturer's instructions?
- Was ensured that the maximum permitted speed n_{max} of the motor is not exceeded? The maximum permitted speed n_{max} ist the highest short-term allowable operation speed.





Tests during operation:

Watch out for unusual noises.

- If scraping, scratching or grinding noises occur, stop the motor immediately and locate the cause.
- Check the motor surface and connection cables for dirt, such as layers of dust, oil deposits, dampness and leaks etc.
- Check air inlet and outlet openings and any interposed filters for dirt accumulation
- Check the maintenance intervals.

4.4 Malfunctions

Safety instructions:

	Error search as well as troubleshooting may be carried out by qualified personnel, only.
	Do not disconnect any of the safety devices – even during test operations
	Disconnect and connect electrical connection cables in de-energized and protected condition, only.
	Observe the five safety disconnection rules (refer to section 3.3).
	Pay attention to hot surfaces!

- refer to the operating instructions of the machine/system
- refer to the operating instructions of the converter
- If necessary, contact the manufacturer of the motor or converter

Have the following parameters ready:

- Type plate data
- Type and scope of malfunction
- Circumstances leading up to the malfunction
- Application data (torque cycle, speed and forces over time; ambient conditions)

The following error cause selection can be helpful with regard to the troubleshooting:

Fault	Cause	Recovery
Motor does not start	No controller enable Controller error, encoder error Brake does not release Brake defect No power supply Rotating field	Activate controller enable Read out error list at converter or controller, troubleshooting Check connections and power supply Repair by manufacturer Check connections and power supply Check phase sequence, if necessary, replace connecting cables
Uneven running	Insufficient screening on connecting cables Controller parameters too high	Check screening connection and grounding Optimize controller parameters
Vibrations	Coupling element or work machine poorly balanced Inadequate alignment of the drive train Fixing screws loose	Rebalance Realign machine set Check and tighten screwed connections
Running noises	Foreign matter in motor Damaged bearing	Repair by motor manufacturer Repair by motor manufacturer
Temperature rise in motor Motor temperature monitoring unit responds	Drive overloaded Brake does not release fully -	Check motor load and compare with type plate Repair by motor manufacturer

	scraping brake Air cooling not active. Fan wheel blocked Air supply inadequate due to ... - Shortcircuit in air flow (exhaust air taken in again) - Filter urgently requires cleaning - Deposits in cooling channels	Check and, if necessary, switch on Remove foreign matter Check air circuit and... - change air flow arrangement - check and, if necessary, clean - check and, if necessary, clean
--	--	--

5 Inspection and maintenance

Working on the electric motor:

	<p>Works at the electric motor may be carried out only if the motor has come to a standstill, is de-energized, depressurized and has cooled down. All connections, such as screw connections, that were loosened must be tightened again after the inspection or maintenance work.</p> <p>When carrying out work on the motor, please observe the technical instructions and notes in the respective chapters in these Commissioning and Maintenance Instructions.</p> <p>When carrying out maintenance work, observe all safety instructions which also apply for the commissioning of the motor (comp. Section 4.1)</p> <p>CAUTION: The optional holding brake does not have a securing function when work is being carried out on the motor (e.g. holding loads)!</p>
---	--

5.1 Inspection

Depending on the local pollution severity, cleaning will have to be carried out regularly on surfaces, air channels and filters to guarantee the continuous dissipation of heat loss.

If equipped with the optional brake, certain abrasion limits are specified (such as maximum permitted ventilation slot, limited emergency braking). The degree of abrasion must be checked on a regular basis. The brake must be replaced on reaching the permitted abrasion limit (refer to Section 5.2)

If equipped with the optional shaft sealing ring, this must be checked regularly to ensure that it is functioning correctly (leaks)..

5.2 Maintenance

Depending on the operating conditions, (e.g. mode, temperature, speed and load), the service life of the bearings and sealing elements can differ greatly.

In the case of troublefree operation, we generally recommend the following maintenance procedures:

- Replacement of the bearings after 20,000 running hours (The bearings are designed for a calculated service life of 20,000 running hours)
- Replacement of the shaft sealing ring, if provided, and if no leaking is detected in the course of previous inspections, after approx. 5,000 running hours.
- Regreasing DA 280..W

Mot. speed	1000 min ⁻¹	1500 min ⁻¹	2000 min ⁻¹	2500 min ⁻¹	3000 min ⁻¹	Grease approx.
Ball bearings	10000 h	5000 h	3000 h	2250 h	1500 h	75 g
Roller bearings	6500 h	3500 h	2000 h	1500 h	1000 h	75 g

We recommend that high-temperature grease, e.g. Klüber - Asonic HQ 72-102 or FAG - L 237, be used for greasing and regreasing.

If equipped with the optional brake, this must be replaced when the specified abrasion limits have been reached.

Maintenance work must be carried out by Baumüller or a specialist company that is commissioned by Baumüller.

The maintenance activities for which the user is responsible, include:

- The cleaning of motor surfaces and air channels
- The replacement or cleaning of filter mats when using dust filters
- The regreasing of drive-end and non-drive-end bearing points for frame size DA 280 (refer regreasing intervals above) or if regreasing was specified as mandatory.

As a rule, dust filters should be cleaned or replaced after 100 operating hours. The maintenance intervals must be shortened accordingly on high dirt accumulations.

Dry dirt accumulations on filters can be removed by suction, blowing or beating. Wet dirt accumulations on filters can be rinsed off under lukewarm water and commercial detergents before allowing the filters to dry.

Note: Only original replacement filters from the motor manufacturer should be used as filter mat replacements. These are available from Baumüller, specifying motor or article number (refer to type plate)

CAUTION!

The technical instruction TAM 00697 must be observed during maintenance and service with motors used in safety-related applications.

6 Disposal

The motor must be disposed in compliance with the national and local regulations within the framework of the normal recycling process.

The encoder electronics (if applicable) must be disposed correctly as electronic scrap.

7 Appendix 1

7.1 Main connection / terminal block designation:

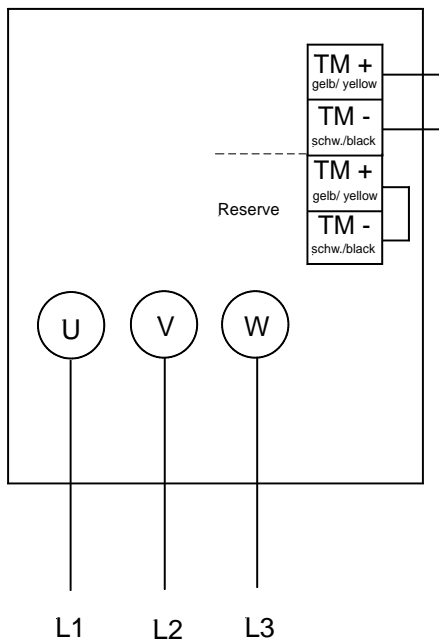

Pin assignment

U V W -----Power connection

TM + TM - -----Temperature sensor

CAUTION:

If using the thermal sensor KTY 84, attention will have to be paid to the polarity during connection.

The cable inlets of the terminal boxes and the main connection terminals are listed below together with the permitted tightening torque.

We recommend EMC screwed fittings for the cable inlets.

It is recommended when tightening the terminal screw to support against the conductor to prevent mounting rail deformation and to keep the terminal base free of torsional forces..

Motor frame size	Cable gland	Number of main connection terminals	Tightening torque for terminals [Nm]
100	1 x M40 + 1 x M25	3x pluggable	-
132	1 x M40 + 1 x M25	3x pluggable	-
	2 x M50 + 1 x M25	3 x M6	3
160	2 x M50 + 1 x M25	3 x M6	3
	2 x M63 + 1 x M25	3 x M10	10
180	2 x M63 + 1 x M25	3 x M12	15.5
	2 x M75* + 1 x M25	3 x M16	30
225	2 x M63 + 1 x M25	3 x M12	15.5
	2 x M75* + 1 x M25	3 x M16	30
280	3 x M80 + 1 x M20	3 x M16	30

* terminal box screening led into terminal in terminal box.

Combination: Terminal box designs

Other cable glands and terminals on request, only.

7.2 Encoder connection

7.2.1 Resolver (standard design) – Pin assignment

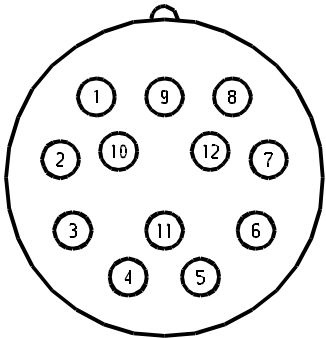
	Pin	Signal
 <p>View to contact side of the female connector</p>	1	cos -
	2	
	3	
	4	
	5	sin -
	6	sin +
	7	
	8	cos +
	9	
	10	Ref +
	11	
	12	Ref -

7.2.2 Sincos-encoder SRS/SRM50 (Fa. SICK / Stegmann) – Pin assignment

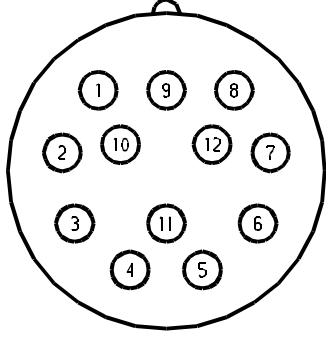
	Pin	Signal
 <p>View to the contact side of the female connector</p>	1	ref cos
	2	+ 485
	3	-
	4	-
	5	sin
	6	ref sin
	7	- 485
	8	cos
	9	-
	10	Gnd
	11	-
	12	+ U

7.2.3 Sincos-encoder ECN1313 / EQN 1325 / EQN 425 (Heidenhain) EnDat 2.1– Pin assignment

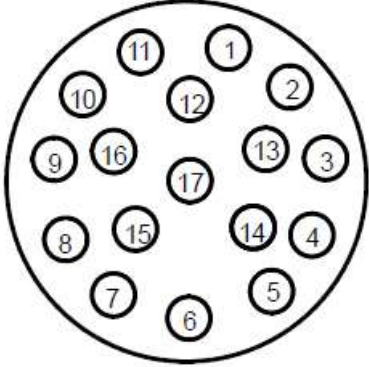
	Pin	Signal
 <p data-bbox="424 797 751 853">View to the contact side of the female connector</p>	1	Up
	2	-
	3	-
	4	0 V
	5	-
	6	-
	7	Up
	8	Clock
	9	Clock inv.
	10	0 V
	11	(Inner shield)
	12	B+
	13	B-
	14	Data
	15	A+
	16	A-
	17	Data inv.

7.2.4 Encoder ECN1325 / EQN 1337 (Heidenhain) Endat 2.2 – Pin assignment (M23)

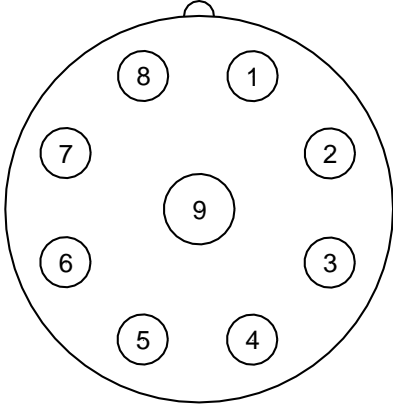
 <p data-bbox="427 840 746 896">View to contact side of the female connector</p>	Pin	Signal
	<p data-bbox="837 353 853 376">1</p> <p data-bbox="837 414 853 436">2</p> <p data-bbox="837 474 853 497">3</p> <p data-bbox="837 535 853 557">4</p> <p data-bbox="837 595 853 618">5</p> <p data-bbox="837 656 853 678">6</p> <p data-bbox="837 716 853 739">7</p> <p data-bbox="837 777 853 799">8</p> <p data-bbox="837 837 853 860">9</p>	<p data-bbox="1050 353 1114 376">Clock</p> <p data-bbox="1027 414 1136 436">Clock inv.</p> <p data-bbox="1066 474 1098 497">Up</p> <p data-bbox="1066 535 1098 557">0 V</p> <p data-bbox="1054 595 1109 618">Data</p> <p data-bbox="1032 656 1131 678">Data inv.</p> <p data-bbox="1023 716 1141 739">Sensor Up</p> <p data-bbox="1023 777 1141 799">Sensor 0 V</p> <p data-bbox="1077 837 1086 860">-</p>

Note: The pin assignment of other encoder types with optional cables of the thermal sensor via the encoder cable can be taken from the enclosed circuit diagrams or from the technical documents.

7.3 Fan connection / terminal designation

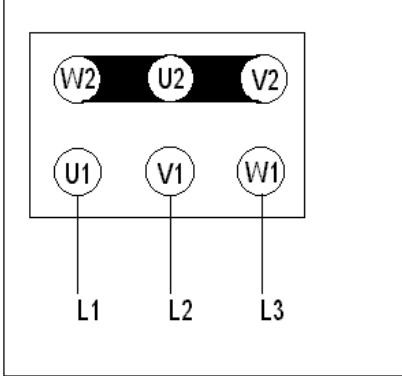
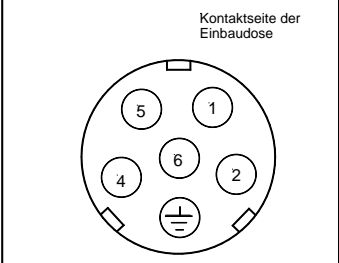
Fan connection for standard fan motor via terminal box	Fan connection for built-in fan motor																																																														
<p>Connection diagram</p>  <p>U V W Power connection</p>	<p>Connection diagram</p>  <table border="1" data-bbox="930 674 1270 831"> <tr> <td>Pin</td> <td>1</td> <td>2</td> <td>4</td> <td>5</td> </tr> <tr> <td>Signal</td> <td>V</td> <td>W</td> <td></td> <td>U</td> </tr> <tr> <td>Pin</td> <td>6</td> <td colspan="2">⏏</td> <td></td> </tr> <tr> <td>Signal</td> <td></td> <td colspan="2">⏏</td> <td></td> </tr> </table> <p>Anschlussschema: Anschluß für Lüfter 6 - poliger Stecker</p> <p>KA 207 i1 10.08.88 Bn</p>	Pin	1	2	4	5	Signal	V	W		U	Pin	6	⏏			Signal		⏏																																												
Pin	1	2	4	5																																																											
Signal	V	W		U																																																											
Pin	6	⏏																																																													
Signal		⏏																																																													
<p>Axially added standard fan motor</p> <table border="1" data-bbox="240 981 850 1249"> <thead> <tr> <th rowspan="2">Frame size</th> <th colspan="3">Rated current in A at Δ/Y:</th> </tr> <tr> <th>Standard 200-265 V 50 Hz 345-460 V 60 Hz</th> <th>265-345 V 50 Hz 460-600 V 60 Hz</th> <th>UL certified 240-280 V 50 Hz 420-480 V 60 Hz</th> </tr> </thead> <tbody> <tr> <td>132</td> <td>0,33</td> <td>0,26</td> <td>0,28</td> </tr> <tr> <td>160</td> <td>0,8</td> <td>0,6</td> <td>0,62</td> </tr> <tr> <td>180</td> <td>1,4</td> <td>1,3</td> <td>1,05</td> </tr> <tr> <td>225</td> <td>3,8</td> <td>2,9</td> <td>3,65</td> </tr> </tbody> </table> <p>The rated current values are maximum values</p>	Frame size	Rated current in A at Δ/Y :			Standard 200-265 V 50 Hz 345-460 V 60 Hz	265-345 V 50 Hz 460-600 V 60 Hz	UL certified 240-280 V 50 Hz 420-480 V 60 Hz	132	0,33	0,26	0,28	160	0,8	0,6	0,62	180	1,4	1,3	1,05	225	3,8	2,9	3,65	<p>Axially built-in fan motor</p> <table border="1" data-bbox="890 981 1385 1323"> <thead> <tr> <th rowspan="2">Frame size</th> <th colspan="4">Rated current in A at Y:</th> </tr> <tr> <th colspan="2">400 V</th> <th>460 V 60 Hz</th> <th>480 V 60 Hz</th> </tr> <tr> <td></td> <th>50 Hz</th> <th>60 Hz</th> <td></td> <td></td> </tr> </thead> <tbody> <tr> <td>100</td> <td>0,13</td> <td>-</td> <td>-</td> <td>0,14</td> </tr> <tr> <td>132</td> <td>0,27</td> <td>0,3</td> <td>-</td> <td>-</td> </tr> <tr> <td>160</td> <td>0,7</td> <td>-</td> <td>0,75</td> <td>-</td> </tr> <tr> <td>180</td> <td>1,3</td> <td>-</td> <td>1,3</td> <td>-</td> </tr> <tr> <td>225</td> <td>2,1</td> <td>-</td> <td>-</td> <td>-</td> </tr> </tbody> </table> <p>The rated current values are maximum values</p>	Frame size	Rated current in A at Y:				400 V		460 V 60 Hz	480 V 60 Hz		50 Hz	60 Hz			100	0,13	-	-	0,14	132	0,27	0,3	-	-	160	0,7	-	0,75	-	180	1,3	-	1,3	-	225	2,1	-	-	-
Frame size		Rated current in A at Δ/Y :																																																													
	Standard 200-265 V 50 Hz 345-460 V 60 Hz	265-345 V 50 Hz 460-600 V 60 Hz	UL certified 240-280 V 50 Hz 420-480 V 60 Hz																																																												
132	0,33	0,26	0,28																																																												
160	0,8	0,6	0,62																																																												
180	1,4	1,3	1,05																																																												
225	3,8	2,9	3,65																																																												
Frame size	Rated current in A at Y:																																																														
	400 V		460 V 60 Hz	480 V 60 Hz																																																											
	50 Hz	60 Hz																																																													
100	0,13	-	-	0,14																																																											
132	0,27	0,3	-	-																																																											
160	0,7	-	0,75	-																																																											
180	1,3	-	1,3	-																																																											
225	2,1	-	-	-																																																											
<p><i>Radially added standard fan motor</i></p> <table border="1" data-bbox="240 1444 850 1848"> <thead> <tr> <th rowspan="2">Frame size</th> <th colspan="3">Nennstrom in A bei Δ/Y:</th> </tr> <tr> <th>Standard 200-265 V 50 Hz 345-460 V 60 Hz</th> <th>265-345 V 50 Hz 460-600 V 60 Hz</th> <th>UL certified 240-280 V 50 Hz 420-480 V 60 Hz</th> </tr> </thead> <tbody> <tr> <td>132</td> <td>0,8</td> <td>0,6</td> <td>0,62</td> </tr> <tr> <td>160</td> <td>1,4</td> <td>1,3</td> <td>1,05</td> </tr> <tr> <td>180</td> <td>3,8</td> <td>2,9</td> <td>3,65</td> </tr> <tr> <td>225</td> <td>8,1</td> <td>6,2</td> <td>5,9</td> </tr> <tr> <td></td> <td>345-460 V 50 Hz 345-480 V 60 Hz</td> <td>-</td> <td>-</td> </tr> <tr> <td>280</td> <td>10,5</td> <td></td> <td></td> </tr> </tbody> </table> <p>The rated current values are maximum values</p>	Frame size	Nennstrom in A bei Δ/Y :			Standard 200-265 V 50 Hz 345-460 V 60 Hz	265-345 V 50 Hz 460-600 V 60 Hz	UL certified 240-280 V 50 Hz 420-480 V 60 Hz	132	0,8	0,6	0,62	160	1,4	1,3	1,05	180	3,8	2,9	3,65	225	8,1	6,2	5,9		345-460 V 50 Hz 345-480 V 60 Hz	-	-	280	10,5																																		
Frame size		Nennstrom in A bei Δ/Y :																																																													
	Standard 200-265 V 50 Hz 345-460 V 60 Hz	265-345 V 50 Hz 460-600 V 60 Hz	UL certified 240-280 V 50 Hz 420-480 V 60 Hz																																																												
132	0,8	0,6	0,62																																																												
160	1,4	1,3	1,05																																																												
180	3,8	2,9	3,65																																																												
225	8,1	6,2	5,9																																																												
	345-460 V 50 Hz 345-480 V 60 Hz	-	-																																																												
280	10,5																																																														

Warranty and liability

All the details in this documentation are unbinding customer information and subject to ongoing change and will be continuously updated by our permanent editing staff. Warranty and liability claims against Baumüller Nürnberg GmbH are excluded if, in particular, the damage is caused by one or more of the following:

- You did not follow the instructions in this documentation
- You did not use the system for the purpose intended
- You
 - mounted, installed, commissioned, operated the system incorrectly or did not carry out the required maintenance
 - mounted, installed, operated and/or maintained the system by unqualified or insufficiently qualified personnel
 - overloaded the system
 - operated the system with
 - defective safety equipment
 - safety equipment which was not correctly mounted or without safety equipment
 - with safety equipment and protective equipment which was not functioning
 - operated the system within ambient conditions which were not stipulated
- You modified the system without the written approval of Baumüller Nürnberg GmbH
- You did not observe the instruction concerning maintenance in the component descriptions
- You monitored the parts subject to wear inadequately
- You made a repair incorrectly
- You combined the system with products of other suppliers improperly
- You combined the drive system with faulty and/or incorrectly documented products of other manufacturers

The latest version of "The General Terms and Conditions of Sale" drawn up by Baumüller Nürnberg GmbH always apply.

These are provided on the conclusion of the contract, at the latest.