

BAUMÜLLER

**COMMUNICATION
SOFTWARE**

Technical description and
operational manual

Edition February 1996

E	5.94032.05
----------	------------

BAUMÜLLER

COMMUNICATION SOFTWARE

Technical description and operation manual

Edition February 1996

5.94032.05

This operation manual is intended as a complement to the technical description and the operation manual of the apparatus.

**READ AND COMPLY WITH THE OPERATION MANUAL AND
THE SAFETY NOTES BEFORE COMMISSIONING**

This manual contains the necessary information for normal operation of the products described therein. The drives may only be used, maintained and repaired by personnel familiar with the operation manual and the applicable regulations on working safety and accident prevention. The devices are manufactured to a high technical specification and are operationally safe. Provided that all safety instructions have been adhered to, there will be no personal danger during the installation and commissioning stages.

The commissioning is prohibited until it has been positively determined that the machine, into which these components are to be incorporated, complies with EC machine regulations.

This technical description replaces and nullifies all previous description. In order to provide the best possible service, we reserve the right to alter information without notice.

Manufacturer and Baumüller Nürnberg GmbH

Supplier's address: Ostendstr. 80
90482 Nürnberg
Germany

Tel. (++49-911) 5432 - 0

Fax (++49-911) 5432 - 130

Copyright: The technical description and the operation manual may not be copied or duplicated without our permission.

Country of origin: Made in Germany

Date of manufacture: Determined from the serial number on the machine/motor.

TABLE OF CONTENTS

1 Service interface.....	1
1.1 Communication PC ⇒ drive.....	1
1.2 Communication drive ⇒ PC.....	3
1.3 Error table.....	4
1.4 Installation	5
1.4.1 Serial PC connection cable.....	5
1.4.2 Connection plan RS 232	6
1.4.3 Accessories	7
1.5 Parameters	8
2 Link to USS protocol.....	9
2.1 Data transmission and data save description	9
2.2 Structure of the net data block	11
2.2.1 Structure of the PIV range	13
2.2.2 Structure of the PD range	19
2.3 Installation	20
2.3.1 Connection cable RS485	20
2.3.2 Accessories	22
2.4 Commissioning the bus system (fixed message length)	23
2.5 Parameters	25

ABBREVIATIONS

ADR	Address byte
ADR	Slave address
BASS	Baumüller drive serial interface
BCC	Block Check Character
BOF	Begin of File
EOF	End of File
ID no.	Identification number
IND	Index
J/RI	Job/reply identification
LGE	Message length
PD	Process data
PDE	Parameter description
PI	Parameter identification
PNU	Parameter numberr
PV	Parameter value
STX	Start of Text
SV	Function module service interface
USS	Function module link to USS protocol

1 SERVICE INTERFACE

The service interface allows communication with the PC user program. The BASS protocol is operated via the RS 232 interface. The address of each drive is set in binary code via the DIP switch. Bit no. 0 thus corresponds to switch 1, bit no. 1 to switch 2 etc.

The RS 232 interface is constructed potential-free, the operating mode is full-duplex.

Data format: 8 data bits, 1 stop bit, no parity

Transmission speed: 9600 baud

Transmission format: ASCII

1.1 Communication PC ⇒ drive

BOF	ADDRESS	CONTROL	ID no.	DATA	CHECKS.	EOF
-----	---------	---------	--------	------	---------	-----

Example 1: Set ID no. 2 to 75 %

#	0	0	0	0	3	E	0	0	0	2	1	D	4	C	E	8	0D	0A
	Write operating data (one element, first transmission)							ID no. 2					1D4C = 7500 = 75 %					

Example 2: Read ID no. 51

#	0	0	0	0	3	C	0	0	3	3	F	D	0D	0A
	Read operating data (one element, first transmission)							ID no. 51						

BOF: # (23_{hex})

Address of the drive: 1_{dec} to 255_{dec} (01_{hex} to FF_{hex})

Control:

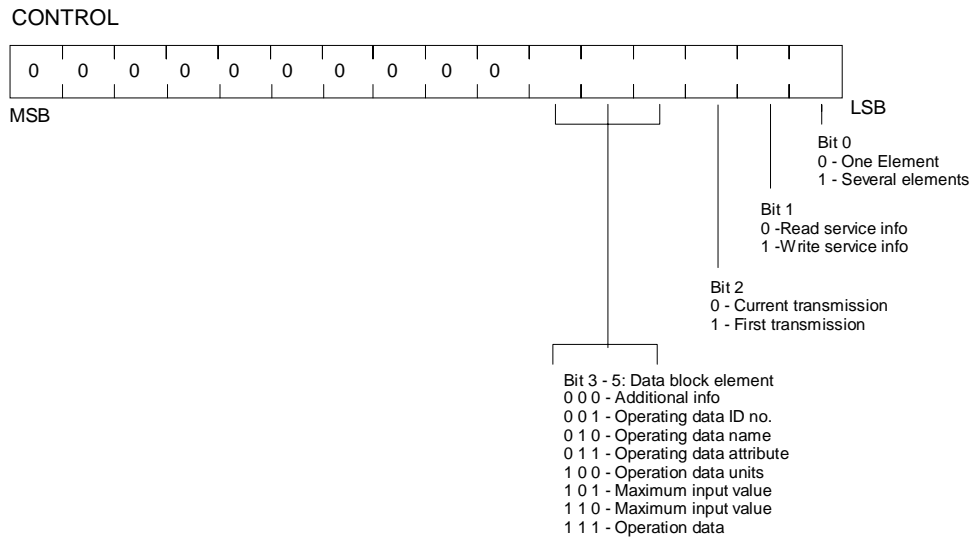

ID no. of the parameter: Hexadecimal value of the identification number as an ASCII character

Data: Element, error type

- Numbers are given as hexadecimals and are transmitted as ASCII characters
- The half-byte with the highest value is transmitted first.
- Eigentliche Texte werden mit zwei aufeinanderfolgenden Worten, die jeweils die Länge des Textes enthalten eingeleitet.

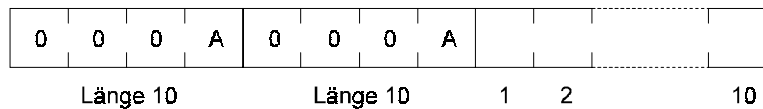

Checksum: Sum of the hexadecimal values of all ASCII characters without BOF and EOF.
Any overflow is also added (234_{hex} → 36_{hex}).

EOF: <CR> <LF> (0D_{hex}, 0A_{hex})

1.2 Communication drive ⇒ PC

Before the drive answered the echo telegram is sended from drive to pc!



Example 1: Set ID no. 2 to 75 %



No error

Example 2: Read ID no. 51

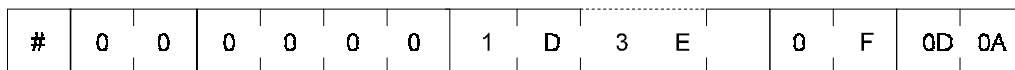

No error

1D3E =
7486 = 74.86 % N actual value

BOF: # (23_{hex})

Adresse of the drive: 0_{dez} bis 255_{dez} (00_{hex} bis FF_{hex})

Status

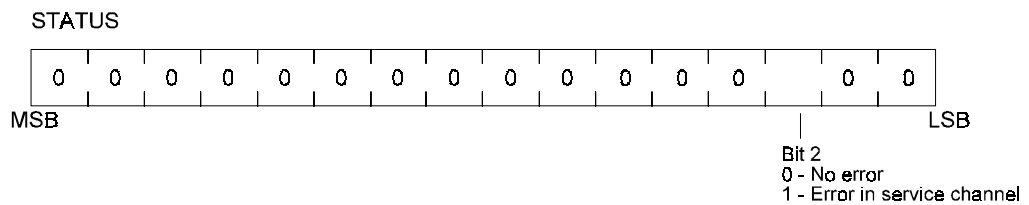

ID no. of the parameter: Hexadecimal value of the ID number as an ASCII character.

Data: Element / data status / error type
Real text starts with 2 words following one after another which contains the length of the text:

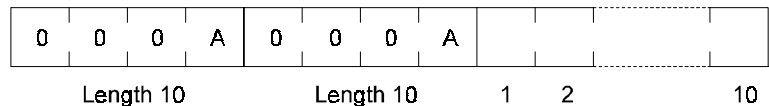

Checksum: Sum of the hex values of all ASCII characters without BOF and EOF.

Any overflow is also added (234_{hex} → 36_{hex}).

EOF: <CR> <LF> (0D_{hex}, 0A_{hex})

1.3 Error table

Error number	Meaning
0	No fault
1	Element is not available
2	Datum is too short
3	Datum is too long
4	Datum is not alterable
5	Parameter is write protected
6	Datum is smaller than minimum value
7	Datum is greater than maximum value
8	Datum is invalid
9	Obtaining of parameter is invalid

1.4 Installation

1.4.1 Serial PC connection cable

- 9-pin PC connection (Interface cable PC, Part no. 1901 8006)

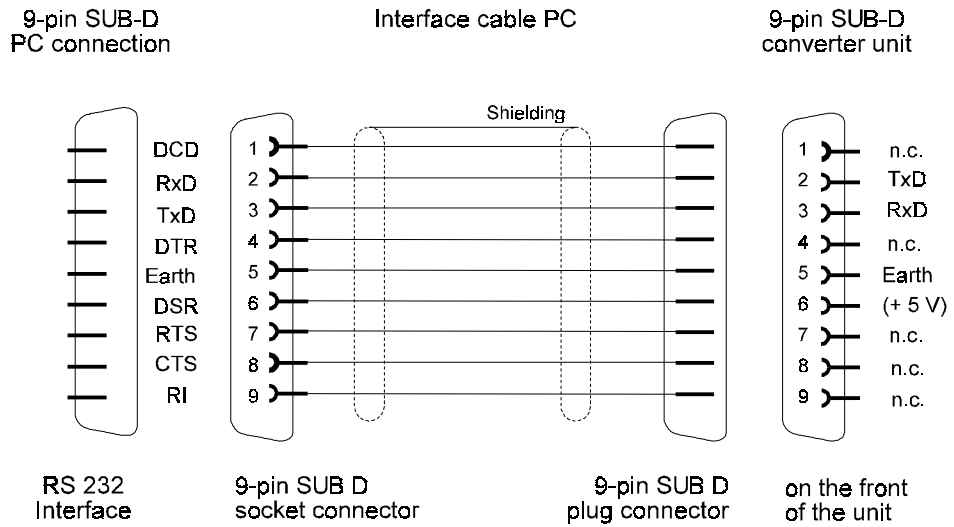

- 25-pin PC connection (not available)

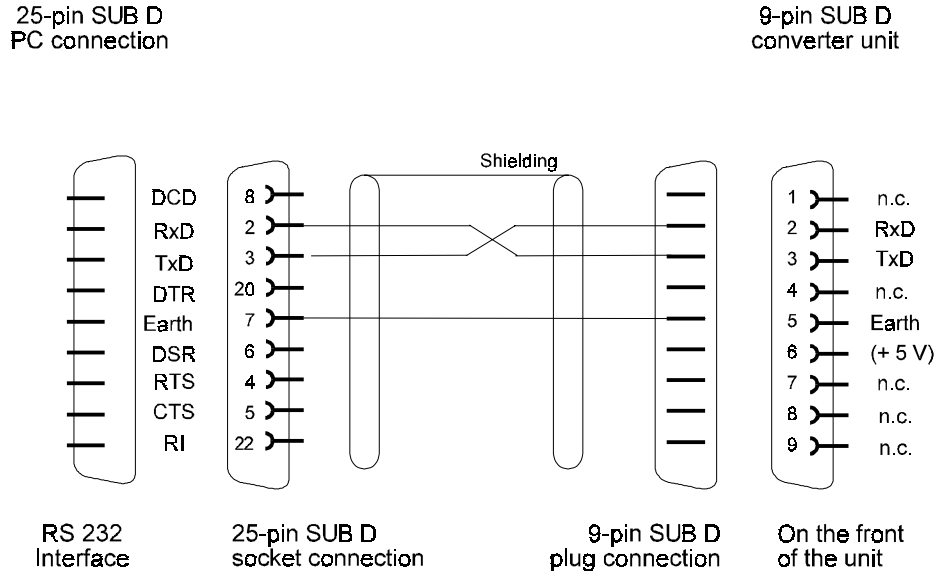

1.4.2 Connection plan RS 232

If several converters are connected in a ring (up to 16), the drives are to be connected in the following way:

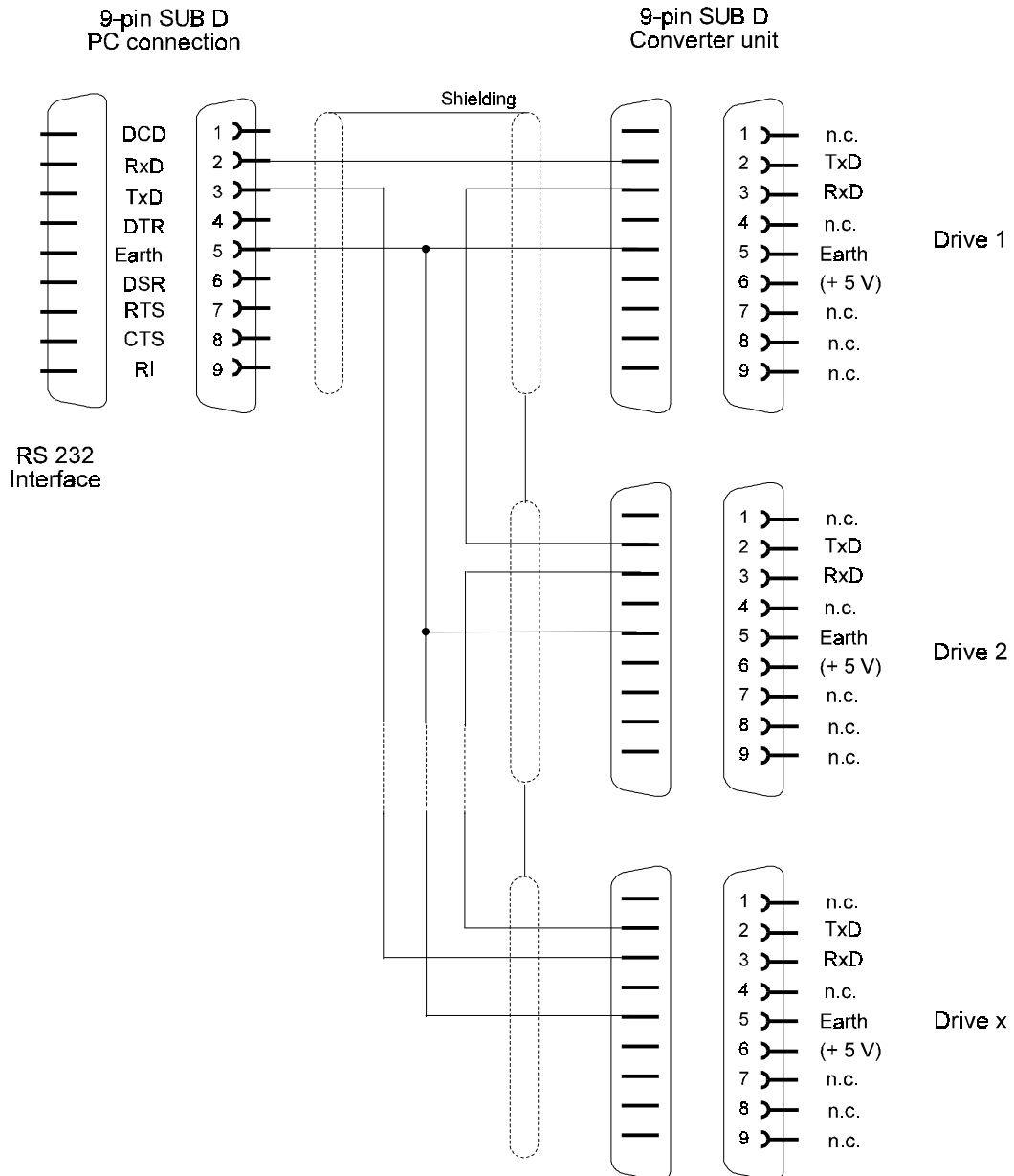

If several converters are connected in a ring, each of the drives must be given an identification number. The identification number, or address, of the drive is set in binary code via the DIP switch.

1.4.3 Accessories

	Part no.
<ul style="list-style-type: none">Interface cable PC (3 m) RS 232	1901 8006

1.5 Parameters

Parameters overview

ID no.	Name	Range min. ... max.	Unit	Standard value	Display only
170	S status	0000 ... FFFF			5
171	S baud rate	50 ... 19200	baud	9600	5

Parameter description

170 S status

Write-access to the drive parameters is managed via parameter M communication source (ID no. 126) in the drive manager. The drive parameter can only be altered via the service interface when bit no. 0 of this parameter is set to 1. If the bit is set to 0 write-access is inhibited and only read-access to the parameter values granted.

See also M communication source (ID no. 126)

Bit no.	Meaning
0 ... 3	module status 0001: RUN (all parameters can be read and written) 0000: STOP (all parameters can be read)
4 ... 11	drive address 0 ... 255 (representation of the DIP switch S401)
12 ... 15	always 0

171 S baud rate

The service baud rate can only be displayed and is set to a fixed value of 9600 baud.

2 LINK TO USS PROTOCOL

The link to USS protocol allows the user to communicate between master and slaves with a fixed message length.

2.1 Data transmission and data save description

(Layer 1 and 2 in the ISO/OSI layer model)

The following arrangement applies to data transmission and data save:

1. The operating mode is strictly half-duplex.
2. It is a bus-capable master-slave protocol, where the non-system computer is the master. The drives are always the slaves.
3. Message length is fixed and cannot be altered online.
4. All messages must be transmitted completely, i.e. with no gaps in them. No acknowledgement or repeat messages are needed due to the cyclic message exchange.
5. The transmission framework for the individual characters is defined as follows:
1 start bit, 8 data bits, 1 parity bit (even parity), 1 stop bit.

The start character of each message (master and slave messages) is the ASCII character STX = 02hex in conjunction with a preceding transmission pause of 33 bits. All other characters in the message are not code-dependent.

A Hamming distance of $d = 4$ is attained via various data saving methods. This means that at least 4 bit errors per message must occur at defined places in the message before a faulty message is no longer recognised as such.

Message structure

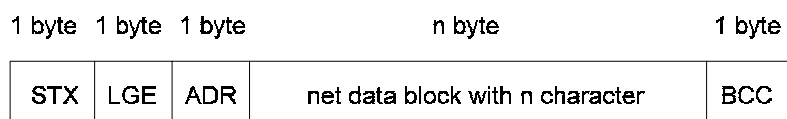

with

STX: Start of Text (02hex)

LGE: Message length 2 - 254 bytes (without STX and LGE, but with ADR and BCC)

ADR: Slave address 0 - 31; 32: broadcast message, = 64: mirror message

BCC: Block Check Character (EXOR linking of all characters)

Transmission procedure

The start character STX (02hex) is not itself enough to mark the start of a message, as this bit combination can also appear in the middle of the message e.g. in the net data block. Thus a transmission pause of 33 bits is stipulated for the master and slave messages. A valid start to a message is only marked when a received STX is preceded by a transmission pause. As a result of the semi-duplex operation (i.e. only transmission or reception at any one time), this start pause is guaranteed when in error-free operation.

The definition of the start pause requires that the pause time never comes between two characters within a message. For this reason, all messages are to be transmitted without gaps.

The drives only respond when they have received a complete and error-free message, sent to their address.

If a slave does not send a reply to a master message, this can result from the following:

- Slave is not yet switched on
- Slave has received a faulty message
- Communication cable is open-circuit or faulty
- Parameter M communication source (ID no. 126) bit no. 2 is not set to 1 (USS protocol)

Normally, the slave sends a reply message for each master message after processing it briefly. Where there are more slaves in use, the procedure is shown in the following diagram:

2-wire and 4-wire modes (half duplex)

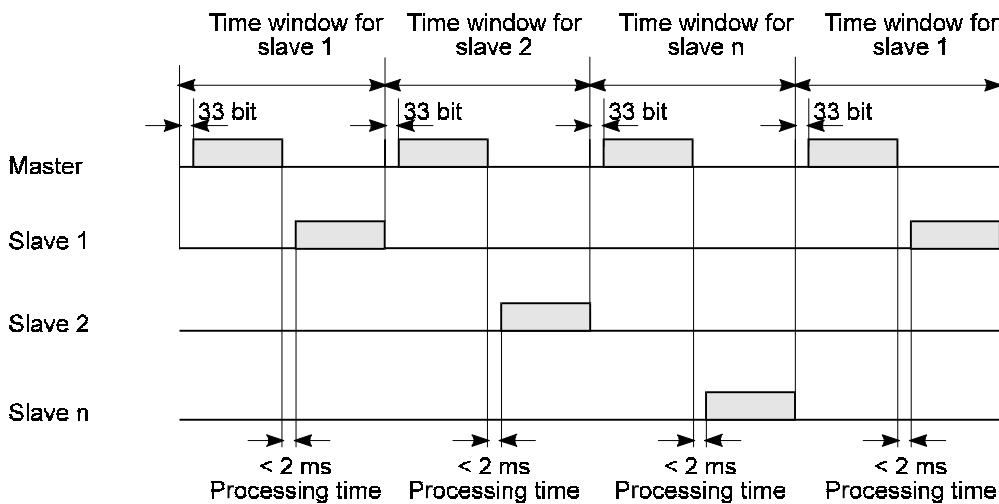

2.2 Structure of the net data block

The net data block is divided into two ranges:

- PIV (Parameter Identification Value) range
 - PD (Process Data) range
- Parameter exchange between the two communication partners, i.e. reading and writing of parameter values and reading of the parameter description is carried out via the PIV range.
 - The PD range contains necessary signals for automation:
control word and specified values from master to slave
status word and actual values from slave to master

Both ranges comprise the net data block. This structure applies to the job message (Master ⇒ Slave) as well as the reply message (Slave ⇒ Master)

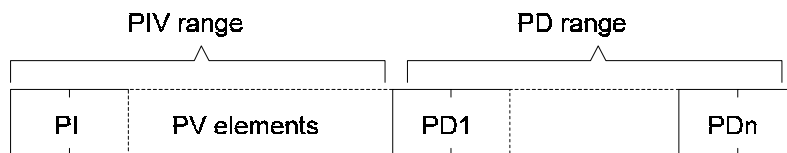

- PI: The parameter identifier (PI) serves to identify and issue jobs and replies for parameter processing, and always has word length (= 16 bits)
- PV element: Parameter value, if necessary with additional or other user data. If only PD data is to be transmitted in the net data block, the number of PV elements can be 0.
- PD1-PDn: Process data (control/status word and specified/actual values)
The necessary specified and actual values are transmitted in this range. The length of this range must be agreed between the drive and the control. If only PIV data is to be transmitted in the net data block, the number of PD elements can be 0.
Depending on the transmission direction, either the control word or the status word is to be transmitted in the PD1. The specified/actual values are transmitted in the following process data PD2 to PDn.

Bus addresses

The bus addresses are set, binary-coded, at the front of the controller with the help of DIP switch. DIP no. 1 thus corresponds to bit no. 0 of the bus address, DIP no. 2 to bit no. 1 etc.

Mirror message

The bus master can request a mirror message from the slave. The master transmits a message to the appropriate slave which only differs from a normal message in that bit no. 7 is set in the address byte ADR.

The slave transmits this message immediately after reception as a reply message to the master. The mirror message allows the transmission function between master and slave to be tested. This is useful e.g. for step-by-step commissioning or fault-finding in the bus system.

Broadcast message

A broadcast message is a master message transmitted simultaneously to all slaves, which only differs from a normal message in that bit no. 32 is set in the address byte ADR (bit no. 5 = 1). Broadcast messages are not answered by the slaves. However, in this case the master does not expect a reply message.

Net data processing takes place as follows:

- Specified values in the PD range are not accepted
- Jobs in the PIV range are not processed
- The control word in PD1 is linked to its screen in PV1, so that only those bits in the drive control word are updated which are set to "1" in the screen. The bits set to "0" are not updated, their old status is retained.

Broadcast mode is only possible when the PIV number is set to > 3 and the PD number to > 1. In addition, the job identifier must be set to 0 "no job".

If PIV number set equal 0 the control word are accepted without screen.

2.2.1 Structure of the PIV range

The structure of the PIV range is always the same in the sequence of its elements and only differs in its standard form by the number of its parameter values (PV).

The PIV range can be set to a specific length (3 or 4 words long) via parameter USS PIV number (ID no. 183).

If no PIV range is to be available in the net data block, the PIV number must be set to 0, then parameters can be assigned via this interface.

- PIV range with set message length

Standard form with parameter values as word size (PIV number = 3)

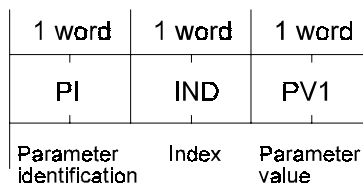

Standard form with parameter values as double word size (PIV number = 4)

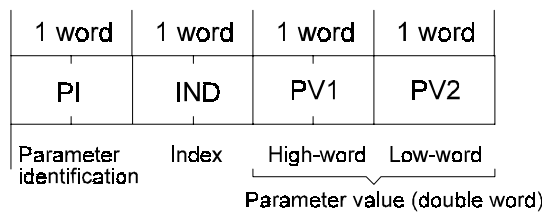

-applies to both job and reply messages.

- Description of the individual PIV elements

Parameter identification (PI)

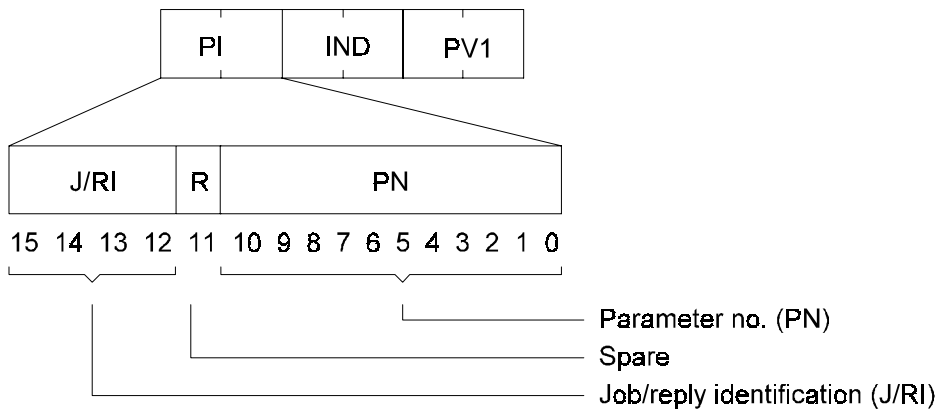

Job and reply identification

The jobs which are sent from the master to the slave are coded in the job identification. The slave processes the job and formulates the relevant reply, which is coded (J/RI) and sent to the master. The J/RI specifies that jobs or replies are clearly defined via the PI (J/RI + PN) and, in the case of certain jobs/replies, additionally via the index word.

Job identification (master⇒slave)

Bit no.				Function	Description
15	14	13	12		
0	0	0	0	no job	no job for the PIV interface
0	0	0	1	request PV	requests a PV
0	0	1	0	change PV (word)	writes a PV word (16 bit)
0	0	1	1	change PV (double word)	writes a PV double word (32 bit)
0	1	0	0	request PDE element	reads an element from the parameter description (PDE); the element to be read can be found in IND.

Reply identification (slave⇒master)

Bit no.				Function	Description
15	14	13	12		
0	0	0	0	no reply	no reply
0	0	0	1	transmit PV (word)	transmits a PV word (16 bit)
0	0	1	0	transmit PV (double word)	transmits a PV word (32 bit)
0	0	1	1	transmit PDE element	transmits an element from the parameter description (PDE); the element to be transmitted can be found in IND.
0	1	1	1	job cannot be processed	error identification in PV, see error identification list

Connection between a job and its reply

Job identification				Reply identification					
Identification		Function		Identification		Function			
0	0	0	0	no job	0	0	0	0	no reply
0	0	0	1	request PV	0	0	0	1	transmits PV (word)
					0	0	1	0	transmits PV (double word)
0	0	1	0	change PV (word)	0	0	1	0	transmits PV (word)
0	0	1	1	change PV (double word)	0	0	1	1	transmits PV (double word)
0	1	0	0	request PDE element	0	0	1	1	transmits PDE element

PDE elements

Value	Meaning
1	parameter attribute
2	parameter info
5	parameter minimum value
6	parameter maximum value

Parameter attribute

Bit	Meaning
0 - 1	length
2 - 3	type
4 - 5	number
6 - 7	element type
8 - 11	format
12 - 15	decimal places

Length:	Data length of an element in bytes	
	00	1 byte
	01	2 bytes
	10	4 bytes
	11	8 bytes
Type:	Data type of an element	
	00	SIGNED complete number with polarity sign
	01	UNSIGNED complete number without polarity sign
	10	FLOAT floating point number
Number:	Element number	
	00	FIXED one element
	01	VARIABLE variable number of elements
Element type:		
	00	DATA
	01	COMMAND
Format:	Display format	
	0000	BIN binary
	0001	DEC decimal
	0010	HEX hexadecimal
	0100	NORM floating point without exponent
	0101	FIX floating point with fixed exponent
	0110	SCI floating point, scientific
	0111	ENG floating point, engineering
	1000	ASCII ASCII character
Decimal places:		
	0000	0 no decimal places
	
	1111	15 15 decimal places

Info

Info is 32 bits long, but only the lower value 16 bits are used. The 16 higher value bits are reserved for future applications.

Bit	Meaning
0 ... 2	write-protection
3	save mode
4 - 15	not assigned

Write-protection:

000	UNPROTECTED	not protected
001	PROTECTED	write-protection level 1

Save mode:

0	NONSTORE
1	STORE

Error identification list

If jobs cannot be processed, the receiver transmits the reply identification "job cannot be processed" and transfers the corresponding error identification in parameter value (PV):

Identification	Description
0	Invalid PN
1	Parameter cannot be altered
2	MIN/MAX limitation
3	Faulty IND
4	No array
5	Wrong data type
6	No setting allowed
7	Description element cannot be altered
:	:
100	Reserved
101	Undefined error
102	Service not implemented
103	Parameter format too big for PIV range
104	PDE element not available

Job/reply processing

Job/reply processing describes the temporal and functional sequence of data transmission for the PIV interface between the master and the slaves.

- The transmitter may only give one job to one slave and must then wait for the corresponding reply identification. As long as it is waiting for the reply identification it must repeat the job.
- The job/reply must be transmitted completely in one message.
- Every alteration of the job means a new job, to which the corresponding reply must be made. Job identification "no job" receives the reply identification "no job".
- If no information from the PIV interface is required in cyclic mode, the job "no reply" must be set.
- If there are large time differences between the cyclic message sequence and reply preparation in the unit, the reply to "old job" is sent during the transition phase between "old job" and "new job" until the new job is received and its corresponding reply given.
- In the case of replies which contain parameter values, the slave always replies, on repetition of the message, with the current value.
- On initial establishment of communication between master and slave, during the transition phase the slave can only reply with the identification "no reply".
- If the transmitter does not receive a reply identification which belongs to its job from the receiver, a corresponding reaction must be triggered in the transmitter.
- The receiver does not expect confirmation from the transmitter that its reply has been received.
- Recognition of an existing job by the master:
The transmitter recognises the correct reply message by evaluating the reply identification, the parameter number, if necessary via the value in IND and the parameter value.
- Recognition of a new job by the slave:
Every job given by the transmitter after reception of a valid reply to an old job is recognised as a new job.
- If the master transmits a broadcast message, the slaves do not send a reply message to the master.

Index (IND)

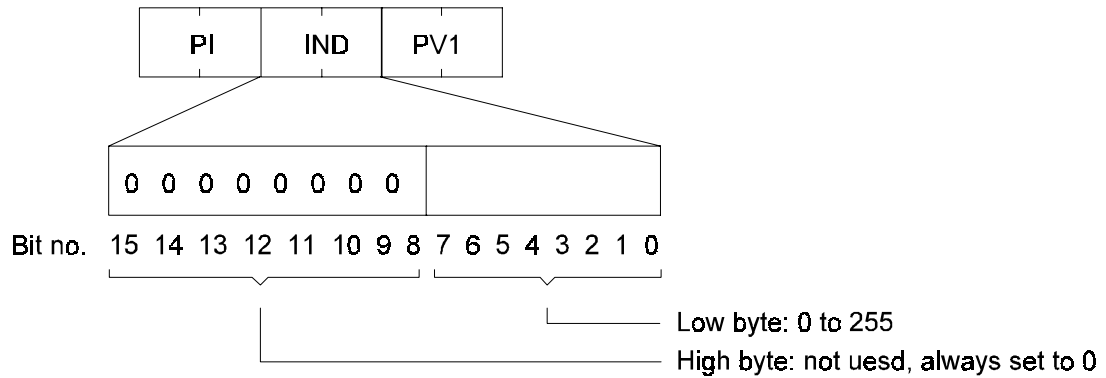

The index is used for writing and reading parameter descriptions.

In all other cases the index is carried as a "zero word" in the message, i.e. all bits are set to 0.

Parameter value (PV)

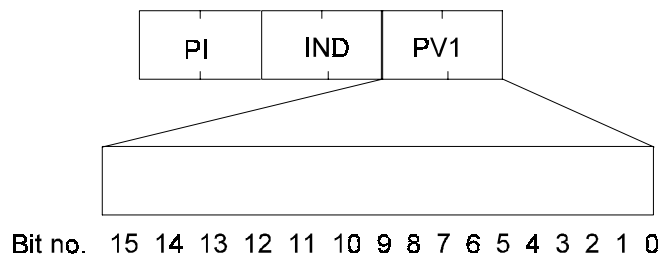

PV allocation is dependent on the existing job, or the corresponding reply.

PIV length for word sizes is always 3 words (PI, IND and PV)

PIV length for double word sizes is always 4 words (PI, IND and PV1 and PV2)

2.2.2 Structure of the PD range

The structure of the PD range is always the same in the sequence of its elements (= words) and only differs from its standard form by the length of the transmitted specified/actual values.

It covers a maximum of 3 words and a minimum of 0 words, i.e. no PD range in the net data block

Standard construction with specified/actual values as word size (PD number = 2):

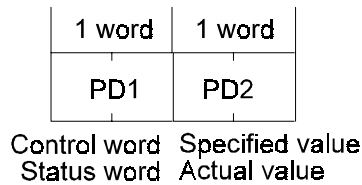

Standard structure with specified/actual values as double word size (PD number = 3):

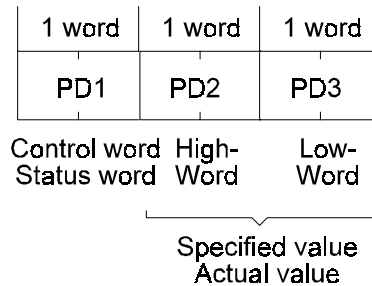

- Description of the individual PD elements

Control word and status word

The meaning of the bits in the control and status words is described in the drive manager under the parameters M control word (ID no. 120) and M status word (ID no. 121).

Specified/actual values

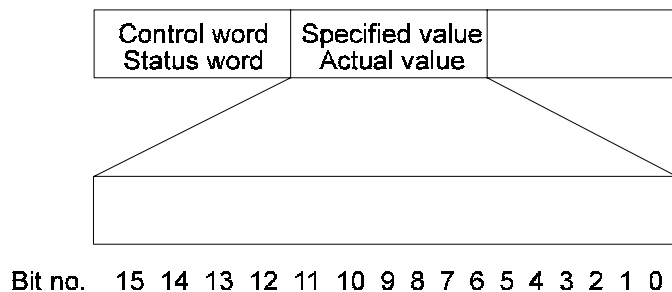

Transmission of specified and actual values in hex figures, where standardisation takes place according to the parameter.

2.3 Installation

2.3.1 Connection cable RS485

- 4 wire connection from master to 1. slave

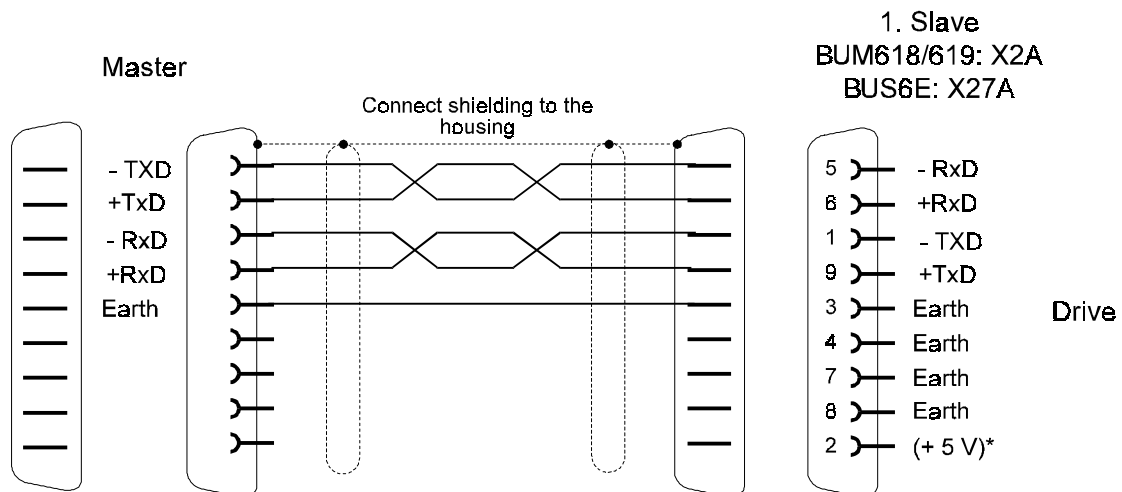

- 2 wire connection from master to 1. slave

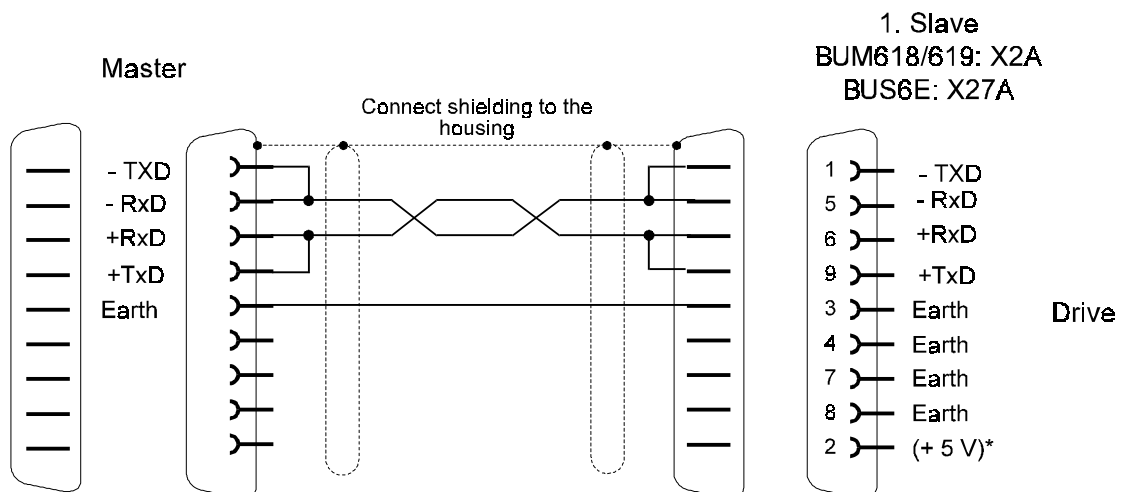

- Connection between 1. and 2. slave and so on

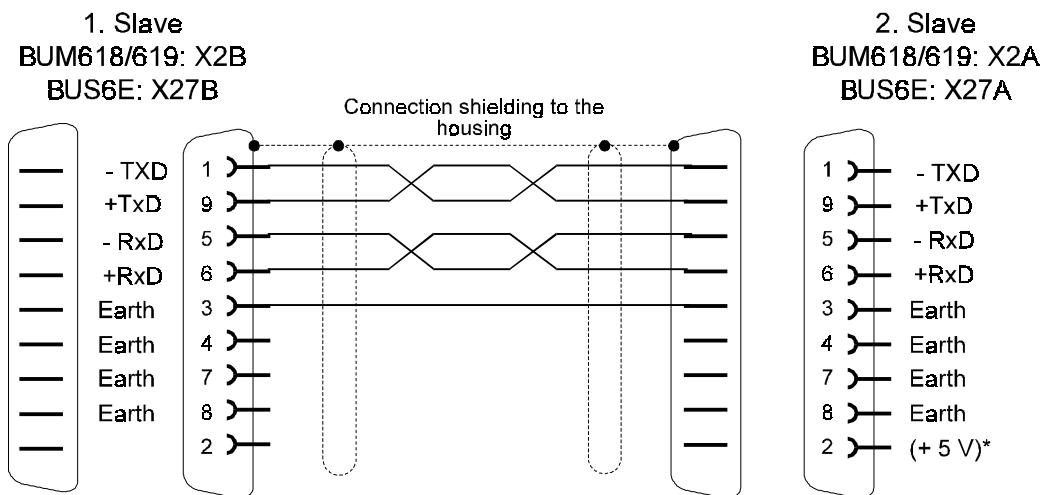

- Busabschluß-Stecker für letzten Busteilnehmer

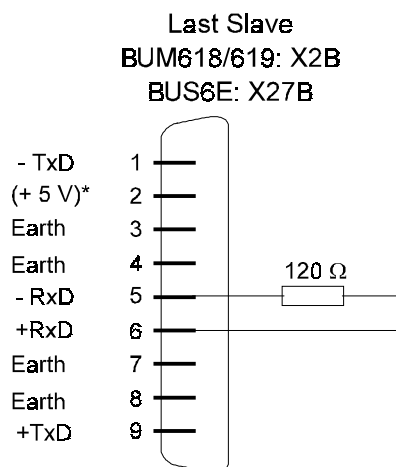

* The +5 V are intended for the power supply of RS485/RS232 adapters and must not be connected

2.3.2 Accessories

	Part no.
<ul style="list-style-type: none">• Bus cable RS 485	1901 8006

2.4 Commissioning the bus system (fixed message length)

The following applies to commissioning communication with the link to USS protocol with set message length:

- For communication between master and slave:
Job and reply messages have the same length, i.e. regarding their PIV range and their PD range.
- This length must be set to a fixed value before initial commissioning of the bus system and may not be altered during use.
- Fixed message length means fixed size of the net data block.
- The size setting of the net data block is via the 2 parameters USS PIV number (ID no. 183) and USS PD number (ID no. 184).
- If the master sets a job whose reply would exceed the set size of the PIV range, this job is answered with the reply identification "job cannot be processed", e.g. the job "PV request double word" cannot be processed with PV number = 3.
- Before setting the net data block size, specify which jobs are to be set by the master. The size of the PIV range is to be based on this. That is, if processing of double words is planned, the PIV range should always be set to 4 words, even if the processing of single words is likely to be more common.

Example messages:

- Example 1: PIV number = 3, PD number = 2

Assignment of word parameters or transmission of specified/actual word values is possible.

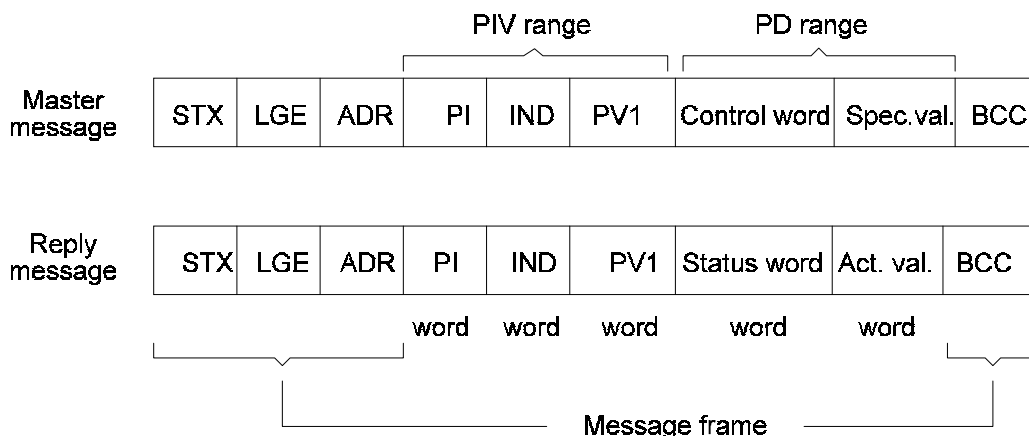

- Example 2: PIV number = 0, PD number = 3

Transmission of specified/actual word and double word values is possible. Parameter assignment via PIV range is not possible.

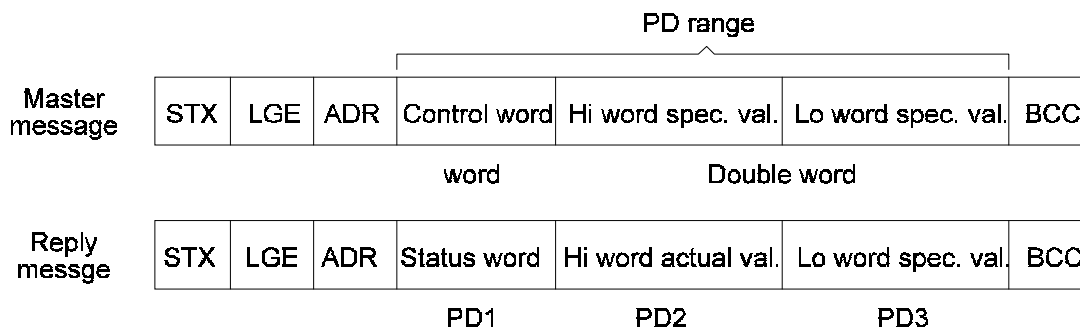

- Example 3: PIV number = 4, PD number = 0

Assignment of word and double word parameters is possible. Specified value entry and drive control is not possible.

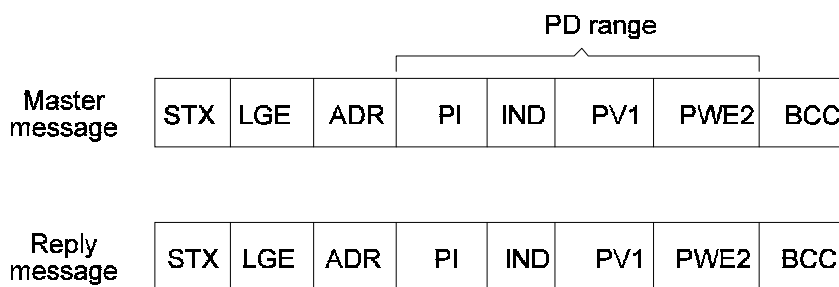

2.5 Parameters

Parameter overview

ID no.	Name	Range min. ... max.	Unit	Standard value	Display only
180	USS state	0000 ... FFFF			5
181	USS mode	0000 ... FFFF		0000	
182	USS baud rate	150 ... 19200	baud	9600	
183	USS PIV number	0 ... 4	words	3	
184	USS PD number	0 ... 3	words	2	
185	USS specified value ID no.	0 ... 500			5
186	USS actual value ID no.	0 ... 500			5

Parameter description

180 USS status

Displays the internal status of the module.

The module function is set via parameter M communication source (ID no.126) of the drive manager. For further details, see the relevant chapter.

Bit	Meaning
0 - 3	0000: module in status STOP. Incoming messages are not answered. 0001: module in status RUN. Message evaluation is active.
4	1: no message received at own address for longer than 1 s
5	1: no message traffic on the bus for longer than 5 s
6	Reserved
7	1: faulty module initialisation
8	1: format error on actual value transfer (see ID no. 186)
9	1: format error on specified value transfer (see ID no. 185)
10	1: error on reading actual value
11	1: error on writing specified value
12 - 15	Reserved

181 USS mode

This parameter sets the USS protocol mode.

Bit no.	Meaning
0	1: specified/actual value standardisation active 0: specified/actual value standardisation inactive
1	1: Broadcast coding activated 0: Broadcast coding not activated
2	1: answer delay active 0: answer delay inactive
3 ... 15	Reserved

Specified and actual value standardisation is selected with bit no. 0.

Apart from specified and actual position values, all specified and actual value parameters are represented as relative sizes. With deactivated specified/actual value standardisation these parameters are represented in original standardisation in the message ($\pm 100.00\%$, ± 2048 etc.), with active standardisation they are referred to 4000h.

Broadcast coding is activated by bit no. 1.

In normal circumstances all of the maximum 32 bus participants are addressed when the broadcast-message is activated. By means of the Broadcast coding one can select for which drive this Broadcast message is set; only those specific drives react to the control word contained in the Broadcast message. The masking of this control word (with the masking of this control word (with the mask transmitted in the PV1 (PIV-range)) remains effective.

- Following requirements must be satisfied for the use of Broadcast coding:
 - USS PIV number (ID no. 183) must be set ≥ 3
 - USS PD number (ID no. 184) must be set ≥ 3
 - USS mode (ID no. 181) bit no. 1 must be set =1.
- The significance of the Broadcast coding is indicated by the following example:
Assuming: PD number = 3, PIV number = 3

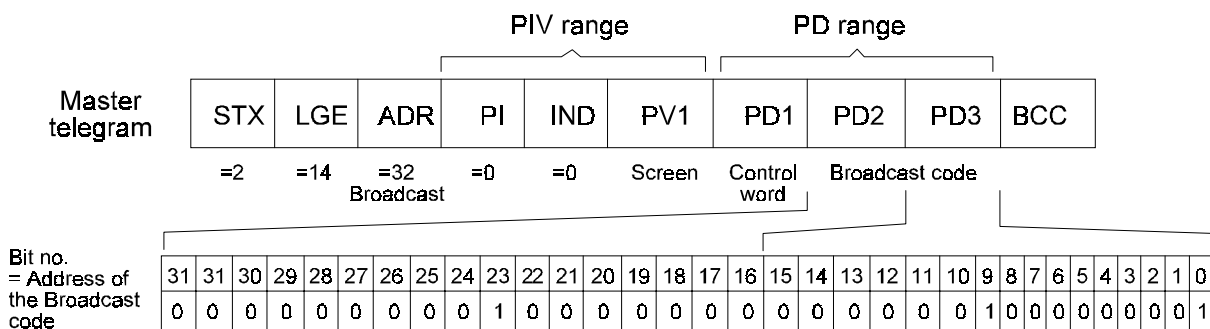

The Broadcast code is set in PD2 (low-word) and PD3 (high-word) and signifies, in this example, that the control word in PD1, masked with the value in PV1, must be accepted and executed by the bus participants with the address 0, 9 and 23. All other bus participants must disregard this information.

The answer delay is selected via bit no. 2

According to the specification of the USS protocol the drive will transmit, after the reception of the master message, its answer message with a maximum delay of 2 ms. Within this short time span a thorough processing of the information contained in the master message will not always be possible (e.g. in PD range). Consequently a prepared answer message (with an incomplete content) is sent back to the master. The correct return answer is only then transmitted to the master in the next message-cycle.

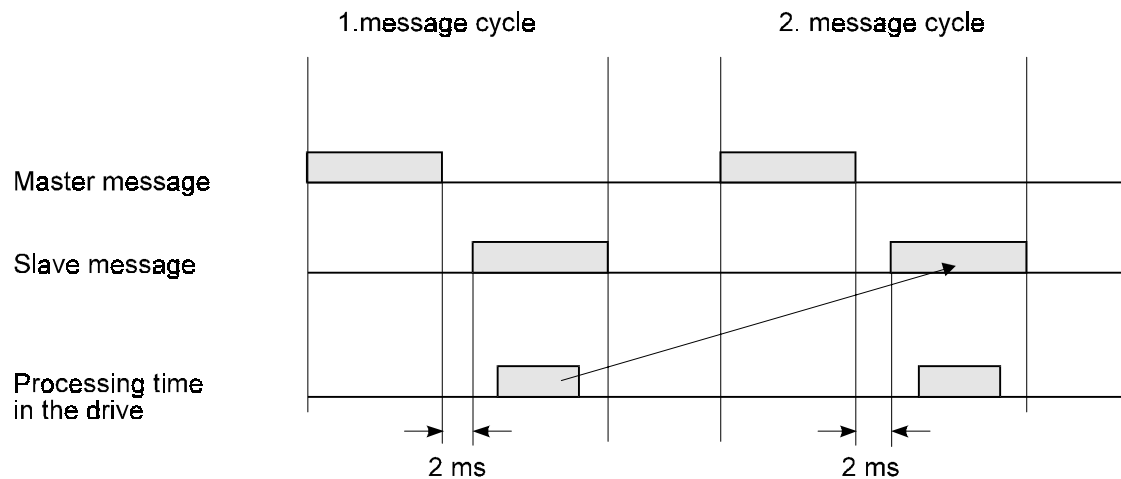

In activating the answer-delay the information contained within processed, after the reception of the master message (and straight after the answer message has been transmitted back to the master (see arrow). A message-cycle is thus saved, however, uncertainty occurs as to exactly when the answer message is transmitted. If the answer-delay is activated then the message timing will no longer correspond to the specification.

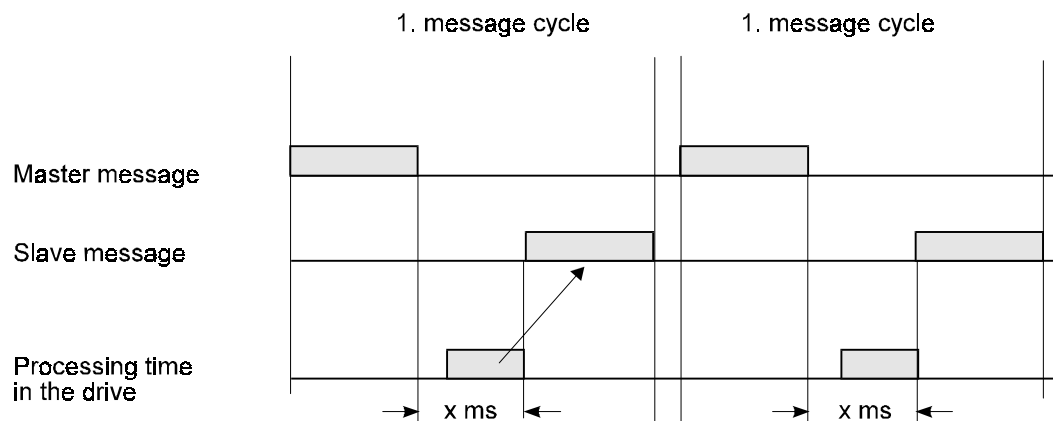

182 USS baud rate

This parameter sets the baud rate for the RS485 interface.

183 USS PIV number

This parameter sets the number of PIV elements available in the PIV range of the net data block. The specification always refers to PIV elements of word length.

Value	Meaning
0	0 words (no parameter assignment possible)
3	constantly 3 words (word parameters)
4	constantly 4 words (double word parameters)

184 USS PD number

The amount of process data contained in the user data block can be influenced by this parameters. The entry is always PD elements with word length.

Value	Meaning
0	no process data
1	control word/status word is transmitted in PD1
2	control word/status word and 16 bit specified/actual values
3	control word/status word and 32 bit specified/actual values

185 USS specified value ID no.

This parameter allows the selection of that drive parameter whose value is to be transmitted as the actual value in the reply message (PD2, PD3). The following stipulation applies to the data exchange:

PD number	Actual value parameter format	Comments
0	16 / 32 bit	specified value channel switched off
1	16 / 32 bit	specified value channel switched off
3	16 bit	specified value transmitted in PD2
3	32 bit	data transmission not possible, bit 9 is set in USS status
4	16 bit	specified value transmitted in PD3
4	32 bit	hi-word of the specified value transmitted in PD2, lo-word of the specified value transmitted in PD3

186 USS actual value ID no.

This parameter allows the selection of that drive parameter which is to be written with the specified value from the master message (PD2, PD3). The following stipulation applies to the data exchange:

PD number	Actual value parameter format	Comments
0	16 / 32 bit	actual value channel switched off
1	16 / 32 bit	actual value channel switched off
3	16 bit	actual value transmitted in PD2
3	32 bit	data transfer not possible bit 8 is set in USS state
4	16 bit	actual value transmitted in PD3
4	32 bit	hi-word of the actual value transmitted in PD2 lo-word of the actual value transmitted in PD3